



mainroads
WESTERN AUSTRALIA

*We're working for
Western Australia.*

Single Trip OSOM Vehicle

Standard Operating Conditions

Printed copies are uncontrolled unless marked otherwise.
Refer to Main Roads website for current version.

D19#696602
August 2022

Contents

REFERENCES AND RELATED DOCUMENTS.....	6
DEFINITIONS	6
1 APPLICATION	9
1.1 General Application	9
1.2 Alternate Vehicles – Oversize Permit Only	9
1.3 Alternate Vehicles – Overmass Permit	9
1.4 Integration with a Low Loader Overmass Period Permit	9
1.5 Integration with a AMMS Period Permit.....	10
2 COMPLYING WITH LICENCING CONDITIONS	10
3 COMPULSORY HEAVY VEHICLE INCIDENT REPORTING.....	10
4 PERMIT STATUS.....	10
4.1 Permit Suspension & Revocation	10
4.2 Permit Amendments & Notifications	11
5 ACCESS CONDITIONS	11
5.1 Route Survey.....	11
5.2 Route Restrictions	11
5.3 Oversize Overmass Transport Management Plans.....	12
5.4 Height Clearance Requirements.....	12
5.5 Width Clearance Requirements.....	12
5.6 Contraflow Movements	13
5.7 Access to Road Train Assembly Areas	13
5.8 Access to Service Stations	14
5.9 Regional Contacts	14
5.10 Other Agency Approvals.....	15
6 DIMENSION REQUIREMENTS	15
6.1 Maximum Dimension Limits.....	15
6.2 Minimising Dimensions	15
6.3 Rear Overhang & Projection.....	16
7 MASS REQUIREMENTS	16
7.1 Maximum Mass Limits	16
7.2 Vehicle Ratings.....	16
7.3 Axle Spacings.....	16
7.4 Ground Contact Width	17
7.5 Crossing Bridges	17
7.6 Block Truck Requirements.....	17
8 SPEED & SAFE TRAVEL CONDITIONS	18
8.1 Speed Restrictions.....	18
8.2 Passing & Overtaking	18
8.3 Minimum Following Distance.....	19

8.4	Poor Visibility	19
9	EMPTY TRAVEL	19
10	CARRYING OTHER GOODS.....	20
11	WARNING DEVICES	20
11.1	Lights	20
11.2	Warning Signs & Flags	20
11.3	Delineators.....	20
11.4	Additional Warning Devices at Night	21
12	PILOT & TRAFFIC ESCORT REQUIREMENTS	21
12.1	Pilot & Traffic Escort General Requirements	21
12.2	Pilot and Escort Vehicle Warning Lights and Signs	22
12.3	Managing Traffic	22
12.4	Position of Pilot and Escort Vehicles	22
12.5	Video Recording Requirements.....	23
12.6	Number of Pilot & Escort Vehicles.....	23
12.7	Additional Pilot Vehicle Requirements.....	23
12.8	Exceptions to the Pilot & Escort Vehicle Requirements - General	24
12.9	Exceptions to the Pilot & Escort Vehicle Requirements - Transportable Buildings	25
12.10	Exceptions to the Pilot & Escort Vehicle Requirements - Swimming Pools.....	25
12.11	Convoy Travel with Pilot & Escort Vehicles	25
13	APPROVED TRAVEL TIMES & CURFEWS	26
13.1	Night Travel Times & Curfews	26
13.2	Metropolitan Area Travel Times & Curfews	27
13.3	Port Hedland Curfew	29
13.4	Christmas & New Year Curfews	29
13.5	Easter Curfews	29
13.6	Long Weekend Curfews	30
14	APPENDICES	30
	Appendix 1: Central Zones	31
	Appendix 2: Metropolitan Area Map.....	33
	Appendix 3: Mandurah Curfew Map	34
	Appendix 4: Fremantle Port Precinct	35
	Appendix 5: Minimum Pilot & Escort Requirements	36
	Appendix 6: Henderson Industrial Estate.....	38
	Appendix 7: Roads Approved for 3 in Convoy	39
	Appendix 8: Road Approved for 4 in Convoy.....	40

Document Control

Owner	Director Heavy Vehicle Services
Custodian	Manager Heavy Vehicle Road Network Access
Document Number	D19#696602
Issue Date	August 2019
Review Frequency	As required

Amendments

Revision Number	Revision Date	Description of Key Changes	Section
1	16/12/2019	Clarified pilot requirements.	Appendix 5
2	17/01/2020	Added provision for alternate trailers.	s.1.2
3	17/01/2020	Added Ord River Diversion Dam condition.	s.5.5
4	24/01/2020	Added provision for alternate prime movers.	s.1.2
5	3/02/2020	Amended wording to clarify vehicle combinations to which this clause applies.	s.9.3.1
6	18/02/2020	Amended clause 12.6.2 to clarify applies to metro only and clause 5.2 to clarify when Traffic Management Plans are required.	s.12.6.2 & 5.2
7	01/04/2020	Clarified incident reporting requirement, bridge clearance requirement and updated curfew tables.	s.3, 5 & 12
8	06/05/2020	Added references to Overmass Period Permit and AMMS permit, increased rear overhang limit, removed additional night pilot requirements for Fremantle Port Precinct and additional pilot requirement on Eyre Hwy, amended curfew limits.	s.1.3, 1.4, 9.3, 11.3, 12.1, 12.2
9	4/06/2020	Clarified curfew limits	s.12.1 & 12.2
10	01/07/2020	Added narrow bridges requirements, introduced requirement to contact the Main Roads Network Operations Centre when conducting contraflow movements and clarified metro curfews.	s.5.4, 5.5 & 12.2.2
11	21/07/2020	Amended table in clause 12.2.1 to link to Appendix 2 (Metropolitan Curfews) not Appendix 5	s.12.2.1
12	07/08/2020	Included reference to drive under structure locations	s.5.3
13	09/09/2020	Updated Compulsory Heavy Vehicle Incident Reporting. Added clause 5.2 Route Restrictions.	s.3 & 5.2

14	1/09/2021	Clarified route restrictions, clarified 300mm width requirement, exemption to TGS requirement for contraflow under a power line, added route exemptions when accessing certain RTAAs and Services Stations, incorporated overmass conditions, clarified speed conditions, added passing and overtaking requirements, updated general pilot and escort requirements, added requirements for positioning pilot vehicles and managing traffic, added exemption to platform trailer escort requirements, updated GEH pilot requirements, clarified convoy requirements on GNH, updated curfew requirements to allow night movements.	cl.5.2, 5.5, 5.6, 5.7, 5.8, 7, 8.1, 8.2, 12.1, 12.2, 12.3, 12.4, 12.8, 12.11 & s.13.
15	15/09/2021	Added the Swagman to Services Stations exemptions, clarified dimension requirements, clarified clearing built up traffic requirements, clarified Metro night TMP requirements.	cl.5.8, 8.2, 12.3, 13.1 & s.6
16	03/12/2021	Allowed convoys Munjina - Royhill Rd and part of Marble Bar Rd.	cl.12.11
17	14/04/2022	Amended wording in sub-clause 5.6.4 to clarify when not considered a contraflow movement to avoid a roadside obstacle, amended sub-clause 7.6.3 to clarify ambient temperature as determined by Bureau of Meteorology, amended wording in clause 5.8(d) to allow access on Richardson St and contraflow on GNH in accordance with relevant Traffic Guidance Scheme, added sub-clause 1.3.4, added sub-clause 12.11.2(f) to allow 3 in convoy on Wodgina Access Road and Pippingarra Access Road, added sub-clause 5.10.5 requiring AAPA permit for Great Central Road, amended finishing time of the approved night hours under clause 13.1, for RAVs up to 8.5 metres wide and 50 metres long from 5:00 am to sunrise, added note under clause 7.5 about drive over structure locations being published in the RAV Mapping Tool. Appendix 5, amended Escort and Pilot Vehicle requirements.	cl.5.6, 7.6, 5.8, 1.3, 12.11, 5.10, 13.1, 7.5 & Appendix 5
18	09/08/2022	Amended alternate vehicles to allow twin steer and single steer to be interchangeable and clarified difference between overmass and oversize only (added cl.1.2). Removed height restriction for access into Coolgardie RTAA. Increased length limit for pilot concession for low loader with dolly. Clarified convoy route assessment requirements and added routes to 4 in convoy provisions.	cl.1.2, 1.3, 5.7, 12.8 & 12.11

REFERENCES AND RELATED DOCUMENTS

The following documents relate to these Operating Conditions and are available on the Main Roads website:

Document Number	Description
D15#453366	Oversize Vehicle & Pilot Vehicle General Requirements
D17#306203	Guidelines for Transporting Multiple Items on an Oversize or Over-mass Vehicle
D19#691324	Oversize Vehicle Route Survey - Audit Regime
D19#398498	Oversize Vehicle Pilot Video - Audit Regime
D18#287647	Contact Details for Other Agency Approvals
D17#69869	Movement of High Risk OSOM Vehicles Policy

DEFINITIONS

The following are definitions for terms used in these Operating Conditions. Refer to the definitions in the *Road Traffic (Administration) Act 2008* and the *Road Traffic (Vehicles) Act 2012* and any subsidiary legislation to these Acts for the meanings of any terms not defined in this section. If a definition in the relevant Acts or the subsidiary legislation conflicts with a definition in this section, the definition in this section prevails for the purpose of these Operating Conditions.

Term	Definition
Central Zones	The area within and including the boundaries of the Perth and Fremantle Central Zones as depicted in Appendix 1 .
Concessional Network	Tandem Drive Concessional Network 1.1, 2.2 or 2.3, available and maintained on the Accredited Mass Management Scheme (AMMS) page or the RAV Mapping Tool on the Main Roads website.
Contraflow Movement	A temporary arrangement on a road where the OSOM vehicle is transferred from its usual side to the other half of the carriageway where traffic is moving in the opposite direction.
Curfew	A period when the movement of an Oversize Vehicle is prohibited.
Day	The period from sunrise to sunset. Sunrise and sunset times can be obtained from the Perth Observatory website at www.perthobservatory.com.au/ or by contacting the Perth Observatory on 08 9293 8255, or from the Geoscience Australia website at http://www.ga.gov.au/geodesy/astro/sunrise.jsp
Escort Vehicle	A vehicle driven by a Traffic Escort Warden that accompanies a RAV for the purpose of facilitating its safe movement.
Fremantle Port Precinct	The area within and including the boundaries of the Fremantle Port Precinct as depicted in Appendix 4 .
Friday Long Weekend	A weekend extended to three days where the preceding Friday is the granted Public Holiday.
Gradeability	The steepness of grade that a motor vehicle is capable of climbing without stalling or losing traction.

Term	Definition
Ground Clearance	The vertical clearance between the lowest point of the load and the ground, including any lashings, straps, chains or other methods required to restrain the load.
Henderson Industrial Estate	The area within the boundaries of the Henderson Industrial Estate as depicted in Appendix 6 .
Large Indivisible Item	an item that: (a) cannot be divided without extreme effort, expense or risk of damage to it; and (b) cannot be carried on any vehicle without exceeding a mass or dimension requirement;
Licensing Authority	A Government Authority responsible for the administration of the vehicle licensing provision of the law of the relevant State, Territory or the Commonwealth.
Main Roads Website	www.mainroads.wa.gov.au – documents referenced within these operating conditions are published on the Oversize Overmass (OSOM) page.
Metropolitan Area	As depicted in Appendix 2 , means the area within: (a) the northern boundaries of the Local Government districts of Wanneroo, Swan and Mundaring; (b) the eastern boundaries of the Local Government districts of Wanneroo, Swan, Mundaring, Kalamunda, Armadale and Serpentine-Jarrahdale; (c) the southern boundaries of the Local Government districts of Serpentine-Jarrahdale and Rockingham; and (d) the Indian Ocean coastline.
Monday Long Weekend	A weekend extended to three days where the following Monday is the granted Public Holiday.
Night	The period from sunset to sunrise. Sunset and sunrise times can be obtained from the Perth Observatory website at www.perthobservatory.com.au/ or by contacting the Perth Observatory on 08 9293 8255, or from the Geoscience Australia website at http://www.ga.gov.au/geodesy/astro/sunrise.jsp
Operator	A representative of the company responsible for the operation of the RAV.
OSOM	An Oversize and/or Overmass Vehicle.
Peak Hours	7.30am to 9.00am and 4.30pm to 6.00pm on a Monday, Tuesday, Wednesday, Thursday or Friday, other than a public holiday.
Permit	A permit issued under Part 4 of the Road Traffic (Vehicles) Act 2012, which these Operating Conditions form part of.
Permit Holder	The Operator to whom the permit is issued.
Pilot	The driver of a pilot vehicle that accompanies a RAV for the purpose of facilitating its safe movement.
Posted Speed Limit	The speed limit indicated by the numerals on the speed limit sign or 50 kilometres per hour in the absence of a speed limit sign in a built-up area.
Projection	The distance an object extends beyond the normal confines or body of the vehicle to the front, side or rear.

Term	Definition
RAV	An Oversize and/or Overmass (OSOM) Vehicle to which the “ <i>Single Trip OSOM Operating Conditions</i> ” apply.
Tandem Drive Network 2	The <i>Tandem Drive Network 2</i> approved roads are published in the form of Road Tables or are available on the RAV Mapping Tool on the Main Roads website.
Tandem Drive Network 5	The <i>Tandem Drive Network 5</i> approved roads are published in the form of Road Tables or are available on the RAV Mapping Tool on the Main Roads website.
Tandem Drive Network 9	The <i>Tandem Drive Network 9</i> approved roads are published in the form of Road Tables or are available on the RAV Mapping Tool on the Main Roads website.
Rear Overhang Line	The centre of a single axle, single axle group, tandem axle group, tri axle group or quad axle group nearest to the rear of the vehicle.
Rear Overhang	Of a vehicle, means the distance between the rear overhang line and the rearmost part of the vehicle or the load.
Single Trip Permit	A permit that is issued to an oversize and/or overmass vehicle for a single movement on a specified route.
Specified Route	The roads listed on a permit on which the RAV is approved to travel.
Traffic Guidance Scheme	A traffic guidance scheme is a documented plan for managing traffic in high-risk situations, such as contraflow movements. There are traffic guidance schemes for common movements approved by Main Roads, which are available on the Oversize Over-mass Permits page on the Main Roads website.

1 APPLICATION

1.1 General Application

These Operating Conditions apply to a RAV operating under a Single Trip Permit issued by Main Roads and stipulating compliance with these Operating Conditions.

1.2 Alternate Vehicles – Oversize Permit Only

Any alternate prime mover, block truck, dolly and / or trailer may be used under a Single Trip Permit that does not approve mass, provided the operator sends notification of the permit number and alternate vehicle's registration number to hvs@mainroads.wa.gov.au prior to commencing movement with the alternate vehicle(s) (No response is required from Main Roads).

1.3 Alternate Vehicles – Overmass Permit

1.3.1 An alternate prime mover or block truck may be used under a Single Trip Permit that approves mass, provided:

- (a) The alternate vehicle must be suitably rated for the approved mass; and
- (b) The alternate vehicle must have the same drive axle configuration as the original vehicle. The steer axle configuration can be either twin steer or single steer; and
- (c) The alternate vehicle must have an axle spacing between 2.9 and 5.8 metres, measured from the centre of the front most steer axle to the centre of the front most drive axle; and
- (d) The alternate vehicle must have an axle spacing between 1.2 and 1.8 metres, measured from the centre of adjacent drive axles; and
- (e) The alternate vehicle must not result in an increase to the approved mass, except where a single steer axle is being changed over to a twin steer axle group.
- (f) The operator must send notification of the permit number and alternate vehicle's registration number to hvs@mainroads.wa.gov.au prior to commencing movement with the alternate prime mover or block truck (No response is required from Main Roads).

1.3.2 Where the vehicle combination is specified on a Single Trip Permit that approves mass, an alternate dolly and / or trailer may be used, provided:

- (a) The alternate vehicle must be suitably rated for the approved mass; and
- (b) The alternate vehicle must have the same axle configuration as the original vehicle; and
- (c) The alternate vehicle must have the same axle spacing's as the original vehicle; and
- (d) The alternate vehicle must have the same, or lesser, tare mass compared to the original vehicle.
- (e) The operator must send notification of the permit number and alternate vehicle's registration number to hvs@mainroads.wa.gov.au prior to commencing movement with the alternate dolly and / or trailer (No response is required from Main Roads).

1.4 Integration with a Low Loader Overmass Period Permit

1.4.1 An oversize Single Trip Permit may be used in conjunction with a *Class 1 RAV Low Loader Overmass Period Permit* or a *Class 1 RAV Restricted Area Low Loader Overmass Period Permit*.

1.4.2 The RAV must only be driven on the route specified in the Single Trip Permit.

1.4.3 Unless specifically approved on the Single Trip Permit, a RAV must not be driven over a bridge that is specified as a restricted bridge in the *Class 1 RAV Overmass Category 1, 2, 3 – Restricted Bridges*, published and maintained on the Oversize Overmass (OSOM) page and the RAV Mapping Tool on the Main Roads website.

1.4.4 Where an inconsistency exists between these Operating Conditions and the *Class 1 RAV Low Loader Overmass Period Permit Operating Conditions* or the *Class 1 RAV Restricted Area Low Loader Overmass Period Permit Operating Conditions*, the relevant period permit operating conditions prevail.

1.5 Integration with a AMMS Period Permit

1.5.1 An oversize Single Trip Permit may be used in conjunction with an *Accredited Mass Management Scheme (AMMS) Period Permit* provided:

- (a) The RAV consists of a prime mover towing a tri axle semi-trailer only; and
- (b) Where the RAV is carrying more than one (1) large indivisible item, the items must be loaded in accordance with the *Guidelines for Transporting Multiple Items on an Oversize or Overmass Vehicle*, except clauses 3.1 and 3.2 of those Guidelines; and
- (c) Where other items are carried in addition to the large indivisible item(s), the additional items must be loaded in accordance with the *Guidelines for Transporting Multiple Items on an Oversize or Overmass Vehicle*.

1.5.2 When operating in conjunction with an *Accredited Mass Management Scheme (AMMS) Period Permit*, the RAV must only be driven on a road specified on the Single Trip Permit and in the relevant Concessional Network that applies to a prime mover towing a semi-trailer.

2 COMPLYING WITH LICENCING CONDITIONS

Drivers and operators are reminded that in addition to these Operating Conditions, the RAV must be driven in accordance with any conditions of the vehicle's licence, as imposed by the relevant licensing authority.

3 COMPULSORY HEAVY VEHICLE INCIDENT REPORTING

All on-road incidents involving a RAV must be reported to Main Roads Heavy Vehicle Services by the permit holder. The Heavy Vehicle Incident Reporting form is available on the Incident Reporting page on the Main Roads website and it must be submitted within 48 hours of the incident occurring.

4 PERMIT STATUS

4.1 Permit Suspension & Revocation

4.1.1 Approval to operate a RAV may be suspended when road and/or traffic conditions are considered unsuitable. Main Roads personnel, WA Police or Traffic Escort Wardens, may make verbal notification of such suspension.

4.1.2 Approval to operate a RAV may be suspended or revoked if the operator or vehicle combination fails to comply with any of the requirements specified in the permit or these Operating Conditions.

4.2 Permit Amendments & Notifications

- 4.2.1** These Operating Conditions are subject to occasional amendments. If amendments are made that impact transport operators, they will be published as an “HVS Update” on the Main Roads website on the first working day of the month. Operators and drivers are required to ensure that they are operating vehicles on the public road network in accordance with the current Operating Conditions.
- 4.2.2** The RAV Networks are subject to periodic amendments, which include additional roads being included in the lists, roads being removed from the lists, or amendments being made to a condition relating to a particular road in the lists. RAV Networks updates will be effective from the Wednesday following the amendment and the RAV Networks are maintained on the Main Road website. Operators and drivers are required to ensure they are operating vehicles on the public road network in accordance with the current and up to date RAV Networks
- 4.2.3** Heavy Vehicle Travel Impacts are published when road conditions may impede the movement of Restricted Access Vehicles. Operators and drivers are required to check the Heavy Vehicle Travel Impacts on the Main Roads website immediately prior to operating the vehicle on the public road network to ensure that there is no relevant information that will impede their vehicle operating on the WA road network.
- 4.2.4** All conditions stipulated in HVS Updates or Heavy Vehicle Travel Impacts must be adhered to. Where a condition stipulates that contact must be made with a site supervisor or any other person prior to travel, this must be done via email or text message and evidence provided to Main Roads’ personnel upon request.

5 ACCESS CONDITIONS

5.1 Route Survey

- 5.1.1** Prior to departure, the operator or driver of the RAV must assess the route of travel to ensure that it is suitable for use and that it can be driven along without contravening these Operating Conditions.
- 5.1.2** The operator must maintain auditable records of the route survey in accordance with *Oversize Vehicle Route Survey - Audit Regime*, available on the Oversize Overmass (OSOM) page on the Main Roads website.
- 5.1.3** A RAV must not be driven along a route or within an area if doing so would be likely to cause:
- (a) Damage to property or another vehicle; or
 - (b) Damage to telecommunication, electrical, gas, water or sewage services; or
 - (c) Damage to a road (including a bridge), structure, roadside furniture, rail crossing or tree.

5.2 Route Restrictions

- 5.2.1** The operator must use the most appropriate route, which wherever possible should consist of State roads and Regional Distributor roads. Where a heavy vehicle bypass exists, this must be used, unless there is a physical constraint.
- 5.2.2** A RAV exceeding 2.5 metres in width and 25 metres in length will only be approved to use the following roads in accordance with clause 5.3 – Oversize Overmass Transport Management Plans and clause 13.1 – Night Travel Times & Curfews:
- (a) Mitchell Freeway;

- (b) Graham Farmer Freeway;
- (c) Kwinana Freeway, north of Anketell Road; and
- (d) Tonkin Highway between Great Eastern Highway and Muchea, if the RAV exceeds 6.5 metres in width and/or exceeds a statutory mass limit that is covered by the single trip permit.

5.2.3 A RAV will only be approved to use Indian Ocean Drive if there is no alternative route available to access the origin or destination.

5.2.4 A RAV travelling through Southern Cross from the west requiring access to locations to the north of Southern Cross must use Three Boys Rd (between Great Eastern Highway and Southern Cross Bullfinch Rd).

5.2.5 A RAV travelling through Southern Cross from the east requiring access to locations to the north of Southern Cross must use Polaris St, Koolyanobbing Rd and Cameron Rd (between Great Eastern Highway and Southern Cross Bullfinch Rd).

5.3 Oversize Overmass Transport Management Plans

5.3.1 An Oversize Overmass Transport Management Plan (OSOM-TMP) is required in the following circumstances:

- (a) The RAV exceeds 8.5 metres in width; or
- (b) The RAV exceeds 50 metres in length; or
- (c) The RAV exceeds the rear overhang limit specified in sub-clause 6.3.1 and 6.3.2; or
- (d) The RAV has a rear projection exceeding 5 metres; or
- (e) Main Roads considers the move a high risk (refer to the Movement of High Risk OSOM Vehicles Policy).

5.3.2 A RAV operating under a permit subject to an accepted OSOM-TMP must be operated in accordance with the OSOM-TMP and must not deviate from the OSOM-TMP without Main Roads approval.

5.4 Height Clearance Requirements

Unless otherwise specified on the permit, a RAV must not travel under a structure unless there is a minimum of 300 millimetres clearance between the load and the structure.

Note: *Drive under structure locations are published on the Oversize Overmass (OSOM) page and the RAV Mapping Tool on the Main Roads website.*

5.5 Width Clearance Requirements

5.5.1 A RAV must not exceed the available width between kerbs (WBK), unless the RAV has a minimum of 1.2 metres ground clearance to ensure the load will clear the bridge guardrails.

5.5.2 If a minimum 300 millimetre clearance between the RAV and any fixed obstacle, including roadside furniture, traffic signals, guardrails etc. is not available due to the width of the load, a spotter must be utilised to guide the driver of the RAV through the obstacle. The driver of a pilot vehicle may perform the function of a spotter, provided it does not affect their ability to perform their duties as the pilot.

Note: *Traffic Guidance Scheme TGS RM0395-18-28 Facilitating Movement of Oversize Vehicle(s) Through Narrow Road Section is available on the Main Roads website to provide guidance when managing traffic at a narrow section of road, such as a bridge, guardrail or similar.*

5.6 Contraflow Movements

- 5.6.1** Contraflow movements must only be conducted in accordance with an approved Traffic Guidance Scheme. If an approved Traffic Guidance Scheme is not available on the Oversize Overmass (OSOM) page on the Main Roads website, the operator must submit a Traffic Guidance Scheme to Main Roads Heavy Vehicle Services for approval.
- 5.6.2** A RAV undertaking a contraflow movement within the Metropolitan Area must contact the Main Roads Network Operations Centre on 138 111 and advise them of the location, date and time of the contraflow movement.
- 5.6.3** A RAV undertaking a contraflow movement within the Perth Central Zone must contact:
- the City of Perth by emailing obstruction.permit@cityofperth.wa.gov.au or phoning (08) 9461 3411 to obtain written approval prior to travel; and
 - Main Roads Network Operations Centre on 138 111 and advise them of the location, date and time of the contraflow movement.
- 5.6.4** This clause does not apply to a RAV required to travel across the centreline of a road, then immediately return to the correct side of the road, to avoid an obstacle, such as a streetlight, parked vehicle, stay wire or power line.

5.7 Access to Road Train Assembly Areas

A RAV may travel off the specified route to access the following Road Train Assembly Areas (RTAA), subject to the respective conditions:

- Where the specified route includes Great Northern Highway past Apple Street in Upper Swan, a RAV with a height not exceeding 8.10 metres may travel off Great Northern Highway directly into Apple Street to access the Apple Street RTAA;
- Where the specified route includes Great Northern Highway, Brand Highway or Tonkin Highway through Muehea, a RAV may access the Muehea RTAA via the Brand Highway / Tonkin Highway interchange and the Road Train Assembly Area Access Road;
- Where the specified route includes Great Northern Highway in Wubin, a RAV may travel off Great Northern Highway directly into Wubin Mullewa Road to access the Wubin RTAA;
- Where the specified route includes Great Northern Highway past Bell Street in Port Hedland, a RAV may travel off Great Northern Highway directly into Bell Street to access the Bell Street RTAA;
- Where the specified route includes Great Eastern Highway past Yilgarn Avenue in Northam, a RAV with a height not exceeding 6.95 metres may travel off Great Eastern Highway directly into Yilgarn Avenue to access the Northam RTAA;
- Where the specified route includes Great Eastern Highway past Lady Loch Road in Coolgardie, a RAV may travel off Great Eastern Highway directly into Lady Loch Road to access the Coolgardie RTAA;
- Where the specified route includes North West Coastal Highway past Harbour Road in Carnarvon, a RAV with a height not exceeding 6.4 metres may travel off North West Coastal Highway directly into Harbour Road to access the Carnarvon RTAA;
- Where the specified route includes North West Coastal Highway past Madigan Road in Karratha, a RAV may travel off North West Coastal Highway directly into Madigan Road to access the Karratha RTAA.

5.8 Access to Service Stations

A RAV may travel off the specified route to access the following Service Stations, subject to the respective conditions:

- (a) Where the specified route includes North West Coastal Highway past the 440 Roadhouse, a RAV may travel off North West Coastal Highway directly into Chapman Road to access the 440 Roadhouse;
- (b) Where the specified route includes North West Coastal Highway past Speedway Road in Carnarvon, a RAV may travel off North West Coastal Highway directly into Speedway Road to access BP Truck Stop Carnarvon;
- (c) Where the specified route includes Great Northern Highway in Paynes Find, a RAV may travel off Great Northern Highway directly into Paynes Find Town Road and Paynes Find Battery Road to access Paynes Find Roadhouse;
- (d) Where the specified route includes Great Northern Highway, Mt Magnet Leinster Road and Richardson Street in Mt Magnet, a RAV with a height not exceeding 7.2 metres may travel along Great Northern Highway for 1 km north of the Mt Magnet Leinster Road intersection to access Swagman Roadhouse. Where the width of the RAV exceeds 6.5 metres, the RAV may contraflow on Great Northern Highway as per Traffic Guidance Scheme TGS RM0395-18-11.
- (e) Where the specified route includes Great Northern Highway past Connaughton Street in Meekatharra, a RAV with a height not exceeding 5.1 metres may travel off Great Northern Highway directly into Connaughton Street to access BP Truck Stop Meekatharra;
- (f) Where the specified route includes Great Northern Highway past Auski Roadhouse, a RAV may travel off Great Northern Highway directly into Nanutarra Munjina Road to access Auski Roadhouse;
- (g) Where the specified route includes Great Eastern Highway past Bodeguero Way in Woorloo, a RAV with a height not exceeding 6.4 metres may travel off Great Eastern Hwy directly onto Bodeguero Way to access El Caballo Roadhouse;
- (h) Where the specified route includes Great Eastern Highway past Yorkrakine Road in Tammin, a RAV with a height not exceeding 5.41 metres may travel off Great Eastern Hwy directly onto Yorkrakine Road to access Tammin Roadhouse;
- (i) Where the specified route includes Great Eastern Highway past Sirius Street in Southern Cross, a RAV may travel off Great Eastern Hwy directly onto Sirius Street to access Shell Southern Cross;
- (j) Where the specified route includes Goldfields Highway or Anzac Drive through the Lane Street / Goldfields Highway / Anzac Drive roundabout in South Boulder, a RAV with a height not exceeding 6.60 metres may travel off the specified route between the roundabout and the BP Truck Stop Kalgoorlie via Goldfields Highway;
- (k) Where the specified route includes Eyre Highway in Norseman, a RAV may travel off Eyre Highway directly into Roberts Roads to access BP Truck Stop Norseman;
- (l) Where the specified route includes Victoria Highway past IQR Petroleum Kununurra, a RAV with a height not exceeding 5.9 metres may travel off Victoria Highway directly into Stockman Road to access IQR Petroleum Kununurra.

5.9 Regional Contacts

The operator or driver of a RAV exceeding 5.5 metres in width and/or 40 metres in length is required to contact the relevant Main Roads Region prior to departure, when travelling on roads within the following regions:

Region	Contact	Contact Number
Any road in the Wheatbelt Region	Main Roads Wheatbelt Regional Office	(08) 9622 4777
Any road in the Mid-West Region	Main Roads Mid-West Regional Office	(08) 9956 1200
Any road in the Gascoyne Region	Main Roads Gascoyne Regional Office	(08) 9941 0777
Travelling through Broome or Derby	Main Roads Customer Service Manager, Kimberley Regional Office	0419 988 334

5.10 Other Agency Approvals

5.10.1 A RAV exceeding 4.3 metres in height must not be driven on a road without current written approval from all of the relevant overhead cable operators.

5.10.2 Despite sub-clause 5.10.1, a RAV up to 4.6 metres in height may travel on any road listed in *Tandem Drive Network 2*, without approval from the relevant cable operator, except where a height restriction is specified as a road condition in *Tandem Drive Network 2*.

5.10.3 A RAV must not be driven on Horrie Miller Drive, north of Paltridge Road, without written approval from Perth Airport Pty Ltd.

5.10.4 If a RAV is crossing the Ord River Diversion Dam on Victoria Highway, Kununurra, in excess of 3.5 metres in width, Water Corporation approval is required. Drivers must initially contact the Water Corporation Dam's Controller at least 1 hour prior to crossing.

5.10.5 An Aboriginal Affairs Planning Authority (AAPA) Lands Permit must be obtained prior to travelling on Great Central Rd. Permits can be obtained through the Department of Planning, Lands and Heritage website.

5.10.6 Written approvals must be carried in the primary towing vehicle and produced upon request.

Note: "Contact Details for Other Agency Approvals" are available on the *Oversize Overmass (OSOM)* page on the Main Roads website.

6 DIMENSION REQUIREMENTS

A RAV is required to comply with statutory dimension limits unless a modified dimension limit is specified on the permit or in this section.

6.1 Maximum Dimension Limits

6.1.1 A RAV must not exceed a dimension limit specified on the permit or in this section.

6.1.2 A semi-trailer or low loader (with or without a dolly) being towed by a prime mover may exceed statutory trailer length limits, provided the RAV complies with the maximum length specified on the permit.

6.1.3 A RAV may exceed the statutory side projection limit, provided the RAV complies with the maximum width specified on the permit.

6.1.4 A RAV may exceed the statutory rear projection limit, provided the RAV complies with the maximum length limit specified on the permit and the rear overhang limit specified on the permit or in clause 6.3.

6.2 Minimising Dimensions

Where a load can be loaded safely in more than one way, it must be loaded in the way that minimises the width of the vehicle.

6.3 Rear Overhang & Projection

- 6.3.1** Unless otherwise specified on the permit, the rear overhang of a RAV consisting of a prime mover towing a semi-trailer or low loader trailer, in excess of 19 metres in overall vehicle combination length, must not exceed the lesser of:
- (a) 25% of the overall length of the RAV; or
 - (b) 7.5 metres.
- 6.3.2** Despite sub-clause 6.3.1, a RAV not exceeding 2.5 metres in width and exceeding 30 metres in length, consisting of a semi-trailer fitted with an engineered headboard, may have a rear overhang up to 8.5 metres.
- 6.3.3** Unless otherwise specified on the permit, a platform trailer must not have a rear projection exceeding 5 metres.

7 MASS REQUIREMENTS

7.1 Maximum Mass Limits

A RAV must not exceed a mass limit specified on the permit.

7.2 Vehicle Ratings

- 7.2.1** All vehicles used as part of a RAV must be suitably rated.
- 7.2.2** Where a block truck is specified on the permit for the purpose of increasing the towing capacity, the aggregated Gross Combination Mass (GCM) rating of the primary towing vehicle and any additional block truck(s), must be sufficient for the gross mass of the RAV.

7.3 Axle Spacings

- 7.3.1** A RAV must comply with all axle spacings, where specified on the permit.
- 7.3.2** Despite the axle spacing specified on the permit for a prime mover or block truck, the axle spacing may be between 2.9 and 5.8 metres measured from the centre of the forwardmost steer axle to the centre of the forwardmost drive axle; and between 1.2 and 1.8 metres measured from the centre of adjacent drive axles.
- 7.3.3** Despite the axle spacing specified on the permit from the rearmost drive axle on the towing vehicle to the forwardmost axle on the trailer (with no dolly), the axle spacing may vary by up to 300 millimetres. Refer to the following example:

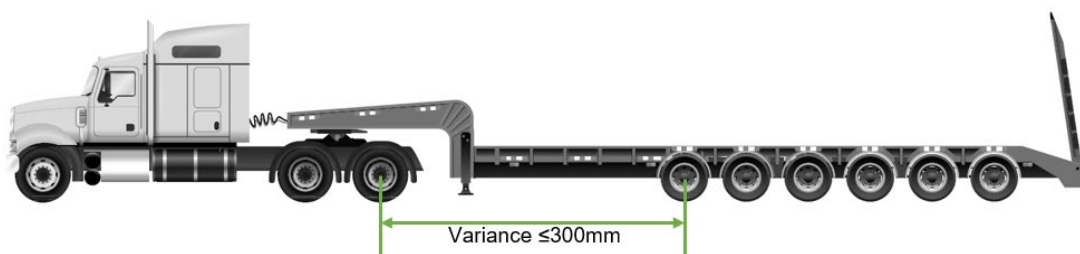

- 7.3.4** Despite the axle spacing specified on the permit from the rearmost drive axle on the towing vehicle to the forwardmost axle on the dolly and from the rearmost axle on the dolly to the forwardmost axle on the trailer, the axle spacing may vary by up to 300 millimetres for each axle spacing, provided the combined variance between the two axle spacings does not exceed 450 millimetres. Refer to the following example:

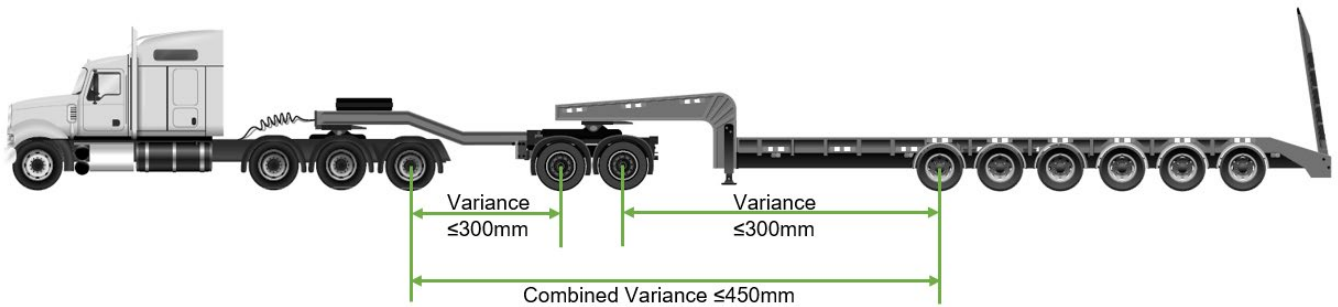

7.4 Ground Contact Width

The dolly and trailer must comply with the ground contact width, where specified on the permit.

7.5 Crossing Bridges

- 7.5.1 An overmass RAV must cross all bridges at a maximum speed of 25 km/h, unless a lower speed for a particular bridge is specified on the permit.
- 7.5.2 An overmass RAV must cross all bridges positioned in the centre of the traffic lanes in the direction of travel, unless another position is specified for a particular bridge on the permit.
- 7.5.3 Where Bridge Video Supervision (BVS) is specified on the permit, the RAV must be operated in accordance with the *Bridge Video Supervision Audit Requirements*, available on the Oversize Overmass (OSOM) page on the Main Roads website.

Note: *Drive over structure locations are published on the RAV Mapping Tool on the Main Roads website.*

7.6 Block Truck Requirements

- 7.6.1 Where the route consists of any gradient exceeding 5%, the operator must ensure the towing vehicle has sufficient gradeability or an additional block truck must be used while ascending the gradients.
- 7.6.2 If an operator considers it necessary to use an additional block truck to facilitate the safe movement of the RAV or reduce the impact on the road surface, an additional block truck may be used, without the need to amend the permit.
- 7.6.3 Unless otherwise specified on the permit, when traversing Bindoon Hill and Little Bindoon Hill on Great Northern Highway, if the ambient temperature (as determined by the Bureau of Meteorology) reaches 35°C or above, a RAV must be connected to the minimum number of block trucks stipulated below:
 - (a) Where the gross mass is >128.5 tonnes and ≤170 tonnes, 1 additional block truck;
 - (b) Where the gross mass is >170 tonnes and ≤245 tonnes, 2 additional block trucks;
 - (c) Where the gross mass is >245 tonnes, 3 additional block trucks.

Note: *The additional block trucks do not need to be specified on the permit.*

- 7.6.4 Unless otherwise specified on the permit, a RAV with a gross mass in excess of 87.5 tonnes traversing Marandoo Hill on Karijini Drive between the hours of 9:30am and midnight, must be connected to the minimum number of block trucks stipulated below:
 - (a) Where the gross mass is >87.5 tonnes and ≤170 tonnes, 1 additional block truck;
 - (b) Where the gross mass is >170 tonnes and ≤245 tonnes, 2 additional block trucks;
 - (c) Where the gross mass is >245 tonnes, 3 additional block trucks.

Note: *The additional block trucks do not need to be specified on the permit.*

- 7.6.5** Unless otherwise specified on the permit, a block truck must have a minimum of 14 tonnes on a tandem drive axle group or 17 tonnes on a tri drive axle group.
- 7.6.6** An additional block truck may operate at higher mass limits in accordance with a *Block Truck Overmass Period Permit*.
- 7.6.7** When connecting an additional block truck to the RAV under the provisions of this clause, the length of the vehicle combination may exceed the maximum length specified on the permit by the length of the block truck.

8 SPEED & SAFE TRAVEL CONDITIONS

8.1 Speed Restrictions

- 8.1.1** A RAV exceeding 3.5 metres in width travelling during the day must not be driven at a speed that exceeds the lesser of:
 - (a) 80 km/h; or
 - (b) 10 km/h below the posted speed limit.
- 8.1.2** A RAV exceeding 2.5 metres in width travelling at night must not be driven at a speed that exceeds the lesser of:
 - (a) 80 km/h; or
 - (b) 10 km/h below the posted speed limit.
- 8.1.3** A RAV approaching a railway crossing must be driven at a speed at which the driver can, if necessary, stop safely before the crossing.
- 8.1.4** A RAV approaching any fixed obstacle, including roadside furniture, traffic signals, guardrails etc. must be driven at a speed at which the driver can safely negotiate the obstacle and if necessary, stop safely.
- 8.1.5** A RAV approaching another vehicle in the opposing direction must be driven at a speed at which the driver can, if necessary, move over or stop safely before passing.

8.2 Passing & Overtaking

- 8.2.1** The driver of a RAV, lead pilot or Traffic Escort Warden must monitor the UHF channel 40 for oncoming RAVs. Where it is identified that two RAVs will need to pass in opposing directions and the road width is not adequate, a RAV passing a suitable parking bay must stop in the parking bay until the approaching RAV passes. All involved parties must communicate with one another to determine who will stop in a parking bay, or if no parking bay is available, move off the road at a suitable location.
- 8.2.2** Where the road width is not sufficient to allow an oncoming vehicle to pass the RAV and for both vehicles to remain on the sealed section of road, the RAV driver must determine which vehicle is a higher risk. Higher risk includes factors, such as heavier axle loadings and higher centre of gravity. The higher risk vehicle must remain on the sealed section of road, where practicable.
- 8.2.3** To avoid unreasonable traffic build up and allow vehicles to pass safely, a RAV in excess of 4.5 metres in width must stop in all suitable parking bays to allow built up traffic to pass.

Note: *Unreasonable traffic build up can include multiple vehicles, as well as a single vehicle that has been held-up behind the RAV for more than 10 minutes, due to a lack of overtaking opportunities. Nothing in this clause prevents a RAV from stopping or slowing down in other suitable and safe areas to allow vehicles to pass safely.*

8.3 Minimum Following Distance

The driver of a RAV must maintain a distance of at least 200 metres from any other heavy vehicle travelling in front of it, unless:

- (a) The RAVs are travelling in convoy in accordance with these operating conditions; or
- (b) The RAV is overtaking the vehicle in front or the vehicle in front is stopping; or
- (c) There is a separate lane available for the use of overtaking traffic; or
- (d) The RAV is in an urban area and it is not reasonably practicable to maintain such a distance; or
- (e) The RAV is stopped, or coming to a stop for the purpose of complying with a provision of any law or avoiding conflict with other traffic.

8.4 Poor Visibility

8.4.1 The driver of a RAV must not begin to travel if, due to circumstances such as fog, heavy rain, smoke, dust or insect plague:

- (a) The visibility is less than 250 metres during the day; or
- (b) The headlights of a vehicle approaching within 250 metres could not be seen at night.

8.4.2 Where a RAV is already travelling when visibility is reduced to the level described above, the driver must drive into the nearest safe parking area, and wait until visibility improves beyond that level before continuing to travel.

9 EMPTY TRAVEL

9.1.1 Empty travel is permitted under a permit issued for the laden journey, provided:

- (a) The RAV does not consist of a platform trailer; and
- (b) The empty travel is for the purpose of picking-up or returning after dropping-off the oversize load to which the permit applies; and
- (c) The RAV is reduced to its minimum practicable dimensions, without needing to disconnect vehicle components; and
- (d) All Operating Conditions applicable to the reduced dimensions are complied with.

9.1.2 When travelling empty, the RAV must not carry a load, however may carry any of the following items, provided they are required for the movement of the oversize load to which the permit applies:

- (a) One (1) pilot vehicle;
- (b) Tools and equipment essential for the loading and securing of the oversize load;
- (c) A gooseneck dolly, providing the RAV does not include a gooseneck dolly as part of the vehicle configuration.

10 CARRYING OTHER GOODS

A RAV may carry other items in addition to the large indivisible item(s), provided the other items are carried in accordance with the *Guidelines for Transporting Multiple Items on an Oversize or Over-mass Vehicle*, available on the Oversize Overmass (OSOM) page on the Main Roads website.

11 WARNING DEVICES

11.1 Lights

11.1.1 A RAV must operate with headlights switched on at all times.

11.1.2 A RAV in excess of 3.0 metres in width or 25 metres in length must display at least one amber flashing warning light, which must be visible in all directions, or must be supplemented by additional warning lights so at least one warning light is visible in all directions.

11.1.3 A warning light must comply with the requirements set out in the *Oversize Vehicle & Pilot Vehicle General Requirements*.

11.1.4 A RAV must not display an amber flashing warning light if not required under this clause.

11.2 Warning Signs & Flags

11.2.1 A RAV exceeding 2.5 metres in width and/or 25 metres in length must clearly display:

- (a) An "Oversize" warning sign on the front of the vehicle; and
- (b) An "Oversize" warning sign on the rear of the vehicle or if carrying a rear projecting load, the "Oversize" warning sign is to be mounted as close to the rear of the load as practical; and
- (c) Four (4) warning flags. One flag must be positioned at each side of both the front and rear of the vehicle, or if there is any projecting load, at each side of both the front and rear of the projecting load.

11.2.2 A RAV with a length exceeding 22 metres, up to 25 metres, and with a width not exceeding 2.5 metres, must only display an "Oversize" warning sign on the rear of the vehicle, or if carrying a rear projecting load, as close to the rear of the load as practical.

11.2.3 An "Oversize" warning sign and a warning flag must comply with the requirements set out in the *Oversize Vehicle & Pilot Vehicle General Requirements*.

11.2.4 A RAV must not display an "Oversize" warning sign if not required under this clause.

11.3 Delineators

11.3.1 If any part of a side projection on a RAV projects more than 150 millimetres and is less than 500 millimetres thick from top to bottom, the vehicle must display:

- (a) A warning light in accordance with clause 11.1; and
- (b) Delineation directly on or in line with both the front and rear of the side projection.

11.3.2 Delineation must be in accordance with the allowable methods set out in the *Oversize Vehicle & Pilot Vehicle General Requirements*.

11.4 Additional Warning Devices at Night

- 11.4.1** If travelling at night, a RAV in excess of 2.5 metres in width or 25 metres in length must display at least one amber flashing warning light, which must be visible in all directions, or must be supplemented by additional warning lights so at least one warning light is visible in all directions.
- 11.4.2** A warning light must comply with the requirements outlined in the *Oversize Vehicle & Pilot Vehicle General Requirements*.
- 11.4.3** A RAV travelling at night must also display:
- (a) Lights showing yellow to the front and red to the rear (known as “side markers”), no more than 2 metres apart along both sides of the vehicle or load; and
 - (b) If in excess of 2.5 metres in width, yellow or white lights (known as “front clearance lights”) on the front of the trailer deck, one on each side of the trailer, as near as practical to the front outer edge and clearly visible to oncoming traffic; and
 - (c) If carrying a load that is not contained within the confines of the vehicle, flood lights attached to the load or the trailer, directed upward at the extremities of the load in a manner so as not to dazzle any driver; and
 - (d) An amber flashing warning light mounted on the extremity of a load projecting more than 1.2 metres from the rear of the vehicle.

12 PILOT & TRAFFIC ESCORT REQUIREMENTS

12.1 Pilot & Traffic Escort General Requirements

- 12.1.1** The pilot vehicle must comply with the requirements stipulated in the *Oversize Vehicle & Pilot Vehicle General Requirements*.
- 12.1.2** The pilot that accompanies a RAV must hold a Heavy Vehicle Pilot Licence, unless specifically stipulated on the permit that an “Agricultural Pilot” may be used.
- 12.1.3** An escort vehicle that accompanies a RAV must only be driven by a Traffic Escort Warden.
- 12.1.4** Where a Traffic Escort Warden is accompanying a RAV, the Traffic Escort Warden is in control of the movement. The driver of a RAV and the pilot must comply with any lawful direction or signal given by the Traffic Escort Warden.
- 12.1.5** The driver of a RAV must comply with any lawful direction or signal given by the lead pilot.
- 12.1.6** The driver of a RAV must produce any applicable permit, OSOM-TMP and Traffic Guidance Scheme to the pilots and Traffic Escort Warden upon request.
- 12.1.7** Prior to accompanying a RAV, the pilot and Traffic Escort Warden must inform themselves of the RAV dimensions, approved route, operating conditions and any applicable OSOM-TMP or Traffic Guidance Scheme. The pilot and Traffic Escort Warden must not accompany a RAV that exceeds the allowable dimensions or does not comply with the operating conditions.
- 12.1.8** The headlights or day running lights on a pilot vehicle or escort vehicle must be switched on when accompanying a RAV.
- 12.1.9** A pilot vehicle or escort vehicle must not tow a trailer or carry a load, but it may carry tools, equipment or substances for use in connection with the RAV it is accompanying.

12.1.10 The pilot or Traffic Escort Warden must not operate any other vehicle or machinery, such as steer a platform or jinker trailer, whilst accompanying a RAV.

Note: *If a RAV is required to be accompanied by a pilot vehicle, the driver of the pilot vehicle must ensure that they comply with each provision of the permit that applies to the pilot vehicle.*

12.2 Pilot and Escort Vehicle Warning Lights and Signs

12.2.1 When accompanying a RAV, pilot vehicles must have amber flashing warning lights operating in accordance with the *Oversize Vehicle & Pilot Vehicle General Requirements*.

12.2.2 When accompanying a RAV exceeding 4.5 metres in width, the lead pilot vehicle must have two “alternating flashing white lights”, known as *Wig Wag Lights*, on the front of the pilot vehicle in accordance with the *Oversize Vehicle & Pilot Vehicle General Requirements*.

12.2.3 When accompanying a RAV, pilot vehicles must have “Oversize Load Ahead” warning signs displayed in accordance with the *Oversize Vehicle & Pilot Vehicle General Requirements*.

12.2.4 When accompanying a RAV, an escort vehicle must have red and blue flashing warning lights operating.

12.2.5 Pilot vehicles and escort vehicles must not have warning lights operating or signs displayed when not accompanying a RAV.

12.3 Managing Traffic

12.3.1 The lead pilot and Traffic Escort Warden must use UHF Channel 40 at regular intervals to warn oncoming traffic of the approaching RAV.

12.3.2 In accordance with clause 8.2, the lead pilot and Traffic Escort Warden must monitor the UHF channel 40 for oncoming RAVs or oncoming higher risk vehicles and must facilitate the RAV or the other vehicles pulling into parking bays, or other appropriate areas, to enable the oncoming vehicles to pass safely.

12.3.3 To ensure the oncoming traffic can pass the RAV safely, the lead pilot and/or Traffic Escort Warden must give clear lawful directions to oncoming traffic to move off the road. If a vehicle is not a sufficient distance off the road to allow clear passage of the RAV, the pilot or Traffic Escort Warden must advise the driver of the RAV and the RAV must stop until the passage is clear.

12.3.4 In accordance with clause 8.2, a rear pilot must monitor the traffic build up at the rear of the RAV and advise the lead pilot or Traffic Escort Warden when there is unreasonable traffic build up. The pilots and Traffic Escort Warden must facilitate the RAV pulling into parking bays or stopping in other safe locations as required to enable vehicles to pass.

Note: *Unreasonable traffic build up can include multiple vehicles, as well as a single vehicle that has been held-up behind the RAV for more than 10 minutes, due to a lack of overtaking opportunities. Nothing in this clause prevents a RAV from stopping or slowing down in other suitable and safe areas to allow vehicles to pass safely.*

12.4 Position of Pilot and Escort Vehicles

12.4.1 When one (1) pilot vehicle accompanies a RAV, the pilot vehicle must travel:

- (a) Behind the RAV when travelling on a road with multiple lanes in the direction of travel (other than overtaking lanes); or
- (b) In front of the RAV when travelling on a road with a single lane in the direction of travel.

12.4.2 When two (2) pilot vehicles accompany a RAV, the pilot vehicles must travel:

- (a) One (1) in front of the RAV and one (1) behind the RAV; or
- (b) Where necessary to manage traffic behind the RAV, both may travel behind the RAV when travelling on a road with multiple lanes in the direction of travel (other than overtaking lanes), provided the RAV does not encroach into oncoming traffic.

12.4.3 Sub-clauses 12.4.1 and 12.4.2 do not apply when it is necessary for the pilot vehicles to be positioned in a different manner for the purpose of managing traffic at intersections, bridge crossings or in accordance with a Traffic Guidance Scheme.

12.4.4 A pilot vehicle and/or escort vehicle must travel far enough ahead of the RAV it is accompanying to give adequate warning to other road users of the presence of the RAV, taking into account the type of vehicles that use the road, traffic speed, road geometry, availability of safe pullover areas, weather, visibility and other driving conditions.

12.4.5 A pilot vehicle and escort vehicle must not travel on or over continuous dividing lines on a carriageway, unless positioning the vehicle in a safe manner to control an intersection or close a road / bridge.

12.4.6 When crossing continuous dividing lines on a carriageway to control an intersection or close a road / bridge, the pilot or Traffic Escort Warden must ensure there is sufficient sight distance available for approaching traffic to see the pilot or escort vehicle and stop safely.

12.5 Video Recording Requirements

12.5.1 A Licensed Heavy Vehicle Pilot's vehicle, accompanying a RAV in excess of 4.5 metres in width, must be fitted with a forward facing video recording device that records the movement in accordance with the *Oversize Vehicle Pilot Video – Audit Regime*.

12.5.2 The Licensed Heavy Vehicle Pilot and the operator of the RAV must comply with the requirements stipulated in the *Oversize Vehicle Pilot Video – Audit Regime*.

12.6 Number of Pilot & Escort Vehicles

12.6.1 A RAV must be accompanied by the minimum number of pilot vehicles and escort vehicles specified in [Appendix 5](#) – Minimum Pilot & Escort Requirements; except where:

- (a) Pilot and escort requirements are specified in the permit; or
- (b) Clause 12.7 – Additional Pilot Vehicle Requirements applies; or
- (c) Clauses 12.8 to 12.10 – Exceptions to Pilot & Escort Vehicle Requirements apply; or
- (d) Additional pilot requirements are specified under clause 12.11 for convoy travel.

12.6.2 For the purpose of [Appendix 5](#), a reference to “Approved Night Hours” means the hours from 9:30pm to 5:00am.

12.7 Additional Pilot Vehicle Requirements

12.7.1 The number of pilot vehicles specified in clauses 12.6 to 12.11 are the minimum number of pilot vehicles required. If an operator considers it necessary to use additional pilot vehicles to facilitate the safe movement of the RAV, additional pilot vehicles may be used.

12.7.2 Where a RAV is operating in accordance with a Main Roads approved Traffic Guidance Scheme or OSOM-TMP, the additional number of pilots identified in the approved scheme or plan must be used.

- 12.7.3** A RAV consisting of an over-length or extendable semi-trailer and carrying a low profile load with a height less than 500 millimetres, must be accompanied by a minimum of two (2) pilot vehicles if:
- (a) The trailer exceeds 9.5 metres in length, measured from the point of articulation (king pin) to the centre of the rear axle group; and
 - (b) The overall combination length exceeds 25 metres.
- 12.7.4** A RAV conducting central movement over bridges in accordance with an overmass permit bridge crossing requirement on Great Eastern Highway, between Roe Highway (Midvale) and Yilgarn Ave (Northam), must be accompanied by a minimum of three (3) pilot vehicles, in addition to any Traffic Escort Warden requirement, if applicable.
- 12.7.5** A RAV in excess of 5.5 metres in width and/or 40 metres in length must be accompanied by a minimum of three (3) pilot vehicles, plus one (1) escort vehicle, when travelling on any of the following section of roads:
- (a) Albany Highway between Bedforddale Road Train Assembly Area and Boddington (including Bannister - Marradong Road to Crossman Road); or
 - (b) Australind Roelands Link (Raymond Road) between Australind Bypass and South Western Highway; or
 - (c) Brand Highway between Muchea and Dongara; or
 - (d) Coalfields Highway (Collie Lake King Road) between South Western Highway and Albany Highway; or
 - (e) Great Eastern Highway, between Roe Highway (Midvale) and Yilgarn Ave (Northam); or
 - (f) Great Northern Highway between Apple Street Road Train Assembly Area and Dalwallinu; or
 - (g) All roads within the Metropolitan Area, if travelling in convoy.
- 12.7.6** A RAV using the crossover between Military Road and Roe Highway, Hazelmere, must undertake the movement in accordance with Traffic Guidance Schemes RM0395-18-08 and RM0395-18-12, available on the Oversize Overmass (OSOM) page on the Main Roads website. The bollard key is to be obtained from Main Roads Heavy Vehicle Services.
- 12.7.7** A RAV exiting Campersic Road onto Toodyay Road must have one (1) additional pilot to manage southbound traffic on Toodyay Road.
- 12.7.8** A RAV using the crossover between Chisholm Crescent and Roe Highway, Kewdale, must undertake the movement in accordance with Traffic Guidance Schemes RM0395-18-23, available on the Oversize Overmass (OSOM) page on the Main Roads website. The bollard key is to be obtained from Main Roads Heavy Vehicle Services.

12.8 Exceptions to the Pilot & Escort Vehicle Requirements - General

- 12.8.1** Except where clause 12.7 applies, a RAV exceeding 25 metres in length, but not exceeding 26 metres in length, may travel on a road specified in *Tandem Drive Network 5* without a pilot vehicle, provided the RAV is not in excess of 2.5 metres in width.
- 12.8.2** Except where clause 12.7 applies, a RAV exceeding 25 metres in length, but not exceeding 30 metres in length, may travel on a road specified in the *Tandem Drive Network 9* without a pilot vehicle, provided the RAV is not in excess of 2.7 metres in width.

- 12.8.3** Except where clause 12.7 applies, a RAV consisting of a prime mover and low loader trailer or platform trailer, without a dolly, does not require a pilot vehicle if the overall length does not exceed 26 metres and the width does not exceed 3.5 metres.
- 12.8.4** Except where clause 12.7 applies, a RAV consisting of a prime mover and low loader trailer or platform trailer, with a dolly, does not require a pilot vehicle if the overall length does not exceed 30 metres and the width does not exceed 3.5 metres.
- 12.8.5** Except where clause 12.7 applies, a RAV consisting of a prime mover and an empty platform trailer, with or without a dolly, does not require a third pilot vehicle, outside of the Metropolitan Area, if the width does not exceed 3.7 metres and the overall length does not exceed 50 metres.
- 12.8.6** A RAV, not exceeding 5.5 metres in width, does not require an escort vehicle within the Metropolitan Area, if an additional block truck is connected to the RAV and the overall length of the RAV does not exceed 40 metres when excluding the length of the additional block truck.

12.9 Exceptions to the Pilot & Escort Vehicle Requirements - Transportable Buildings

- 12.9.1** For a prefabricated transportable building, only one pilot vehicle is required where:
- (a) The maximum width at the base of the building is 4.5 metres, plus 100 millimetres tolerance for external fittings, and
 - (b) The maximum width at the eaves is 5 metres.
- 12.9.2** This pilot exception does not apply for the transport of a prefabricated transportable building within the Central Zones.

12.10 Exceptions to the Pilot & Escort Vehicle Requirements - Swimming Pools

- 12.10.1** For a single swimming pool, only one pilot vehicle is required where:
- (a) The maximum width at the base of the swimming pool is 4.5 metres, and
 - (b) The maximum width at the flange is 4.9 metres; and
 - (c) The flange of the swimming pool is the top of the load.
- 12.10.2** This pilot exception does not apply to packaged export swimming pools.
- 12.10.3** This pilot exception does not apply to the transport of a swimming pool within the Central Zones.

12.11 Convoy Travel with Pilot & Escort Vehicles

- 12.11.1** RAVs may travel in convoy if stipulated under this Clause, provided:
- (a) The transport operator has a documented contingency plan to manage the RAVs in the event of a mechanical failure; and
 - (b) The transport operator has a documented plan for fatigue breaks and other required stops to ensure the parking areas are suitable to safely accommodate all RAVs the convoy.
- 12.11.2** A maximum of two (2) RAVs may travel in convoy with one another when accompanied by the appropriate number of pilot or escort vehicles, except where:
- (a) The permit restricts convoy travel; or
 - (b) Additional RAVs are approved to travel in convoy on the permit; or

(c) Additional RAVs are approved to travel in convoy under this Clause.

12.11.3 Three (3) RAVs may travel in convoy while travelling on a road listed in [Appendix 7](#).

12.11.4 Four (4) RAVs may travel in convoy while travelling on a road listed in [Appendix 8](#), provided an additional pilot vehicle accompanies the convoy.

12.11.5 When travelling empty on Great Northern Highway, five (5) RAVs may travel in convoy between Port Hedland and Boodarie, including the adjoining local road(s) required to directly access the origin or destination, provided:

- (a) An escort vehicle accompanies the convoy; and
- (b) An additional pilot vehicle accompanies the convoy; and
- (c) Travel occurs between 10:00pm and 6:00am.

12.11.6 A RAV must not travel in convoy when required to be accompanied by a pilot or escort vehicle when travelling within a Central Zone.

12.11.7 RAVs must not travel in convoy on Horrie Miller Drive, north of Paltridge Road in Perth Airport.

12.11.8 The length of a convoy travelling outside of the Metropolitan Area must not exceed a static length of 200 metres, excluding the pilot and escort vehicles, unless otherwise specified on the permit.

12.11.9 A RAV exceeding 50 metres in length must not travel in convoy within the Metropolitan Area, unless otherwise specified on the permit.

12.11.10 Each RAV in the convoy must obtain a separate permit.

12.11.11 When RAVs are travelling in convoy, the pilot vehicle requirements and any other conditions that are applicable to the largest combination, apply to the convoy.

12.11.12 The distance between RAVs travelling in convoy must not exceed 100 metres.

13 APPROVED TRAVEL TIMES & CURFEWS

13.1 Night Travel Times & Curfews

A RAV must not travel at night except where:

- (a) Specified on the permit; or
- (b) The RAV is of a type described and travelling on the roads specified in the following table.

RAV Type	Overall Length	Overall Width	Permitted Roads
Any RAV	≤22 metres	≤2.7 metres	Any road, subject to clause 5.2 route restrictions.
A RAV, other than a rigid vehicle towing a dog trailer	≤23 metres	≤2.7 metres	Roads outside the Metropolitan Area listed in <i>Tandem Drive Network 2</i> .

A RAV that is a rigid vehicle towing a dog trailer	≤25 metres	≤2.7 metres	Roads outside the Metropolitan Area listed in <i>Tandem Drive Network 2</i> .
Any RAV	≤26 metres	≤2.7 metres	Roads outside the Metropolitan Area listed in <i>Tandem Drive Network 5</i> .
	≤30 metres	≤2.7 metres	Roads outside the Metropolitan Area listed in <i>Tandem Drive Network 9</i> .
	≤26 metres	≤3.5 metres	The Freeways, between 9:30pm and 5:00am only.
	≤50 metres	≤4.0 metres	In accordance with sub-clause 12.11.5.
	Any Length within the Permit Limits	Any Width within the Permit Limits	Roads within the Fremantle Port Precinct.
	Any Length within the Permit Limits	Any Width within the Permit Limits	Roads within the Henderson Industrial Estate.
	≤50 metres	≤8.5 metres	The Freeways, between 9:30pm and 5:00am only, subject to clause 5.3.
Any RAV	≤50 metres	≤8.5 metres	<ol style="list-style-type: none"> 1) All Roads within the Metropolitan Area, exclusive of the Freeways, between 9:30pm and sunrise only. 2) The sections of Tonkin Highway and Great Northern Highway from the Metropolitan Area boundary to the Muchea RTAA, between 9:30pm and sunrise only. 3) Kwinana Freeway south of Anketell Road and Forrest Highway, between 9:30pm and sunrise, provided the RAV is not travelling within the Metropolitan Area after 5:00am. The RAV may only travel off Forrest Highway prior to sunrise to access Kemerton Industrial Estate, Bunbury Port or the Willinge Drive Road Train Assembly Area.
	>50 metres	>8.5 metres	All Roads within the Metropolitan Area, inclusive of the Freeways, between 9:30pm and 5:00am only, subject to clause 5.3.

13.2 Metropolitan Area Travel Times & Curfews

13.2.1 A RAV must not travel within the Metropolitan Area during peak hours except where;

- (a) Specified on a permit; or

(b) The RAV is of a type described and travelling on the roads specified in the following table.

RAV Type	Overall Length	Overall Width	Permitted Roads
Any RAV	≤22 metres	≤2.7 metres	Any road, subject to clause 5.2 route restrictions.
A RAV, other than a rigid vehicle towing a dog trailer	≤23 metres	≤2.7 metres	Roads listed in <i>Tandem Drive Network 2</i> , except on a Freeway.
A RAV that is a rigid vehicle towing a dog trailer	≤25 metres	≤2.7 metres	Roads listed in <i>Tandem Drive Network 2</i> , except on a Freeway.
Any RAV	≤26 metres	≤2.7 metres	Roads listed in <i>Tandem Drive Network 5</i> , except on a Freeway.
	Any Length within the Permit Limits	≤3.1 metres	Roads within the Fremantle Port Precinct.
	Any Length within the Permit Limits	Any Width within the Permit Limits	Roads within the Henderson Industrial Estate.
	≤50 metres	≤8.5 metres	Approved roads within Metropolitan Area during curfew, as depicted in Appendix 2 .

13.2.2 A RAV travelling during peak hours must not exceed the statutory rear overhang limit, as prescribed in the *Road Traffic (Vehicles) Regulations 2014*.

13.2.3 A RAV must not travel within the Metropolitan Area during the day (outside of peak hours), except where the RAV is travelling on the roads and during the times specified in the following table:

Overall Length	Overall Width	Approved Times	Permitted Roads
≤40 metres	≤6.5 metres	Any time outside of peak hours.	Any road, subject to clause 5.2 route restrictions.
Any Length within the Permit Limits	≤8.5 metres	Any time outside of peak hours.	Roads within the Fremantle Port Precinct.
Any Length within the Permit Limits	Any Width within the Permit Limits	Any time.	Roads within the Henderson Industrial Estate.

>40 metres ≤50 metres	>6.5 metres ≤8.5 metres	Monday to Friday, between 09:30am and 2:00pm only.	Any road, subject to clause 5.2 route restrictions.
		Saturday and Sunday, between 5:00am and Sunset.	Any road, subject to clause 5.2 route restrictions.
		Monday to Friday any time outside peak hours.	Approved roads within Metropolitan Area during curfew, as depicted in Appendix 2 .

13.2.4 For the purpose of this clause, if a RAV consists of two (2) towing vehicles (blocks trucks), the second towing vehicle (block truck) is excluded from the length measurement.

13.3 Port Hedland Curfew

13.3.1 A RAV exceeding 5.5 metres in width and/or 40 metres in length must not travel between 6:00am and 9:00am within the Town of Port Hedland, including Wedgefield, South Hedland, Port Hedland, Cooke Point and Pretty Pool.

13.3.2 During this curfew period, travel is permitted on Great Northern Highway, south of Powell Road and East of Bell Street, and on Bell St, between Great Northern Highway and the Road Train Assembly Area.

13.4 Christmas & New Year Curfews

13.4.1 A RAV exceeding 2.7 metres in width and/or 30 metres in length must not travel on Forrest Highway and Lakelands Lake Clifton Road (includes Mandurah and Dawesville Bypasses), between the intersections of Pinjarra Road and Peppermint Grove Road, during the period from sunset on 18th December until sunrise on 4th January. Refer to the [Appendix 3 – Mandurah Curfew Map](#).

13.4.2 A RAV exceeding 4.5 metres in width, but not exceeding 5.5 metres in width, and/or exceeding 30 metres in length, but not exceeding 40 metres in length, must not travel on any of the following roads during the periods from sunset on 23rd December until sunrise on 27th December and from sunset on 30th December until sunrise on 4th January:

- (a) Albany Highway (Bedforddale Road Train Assembly Area, to Albany)
- (b) Brand Highway
- (c) Eyre Highway
- (d) Great Eastern Highway
- (e) South Western Highway (Armadale to Bunbury)
- (f) Great Northern Highway (Roe Highway to Mt Magnet)

13.4.3 A RAV exceeding 5.5 metres in width and/or 40 metres in length must not travel on any road in Western Australia during the period from sunset on 18th December until sunrise on 4th January.

13.5 Easter Curfews

13.5.1 A RAV exceeding 2.7 metres in width and/or 30 metres in length must not travel on Forrest Highway and Lakelands Lake Clifton Road (includes Mandurah and Dawesville Bypasses), between the intersections of Pinjarra Road and Peppermint Grove Road, during the period from sunset on the Wednesday before Good Friday until sunrise on the Tuesday after Easter Monday. Refer to the [Appendix 3 – Mandurah Curfew Map](#).

13.5.2 A RAV exceeding 4.5 metres in width and/or 30 metres in length must not travel on any road in Western Australia during the period from sunset on the Wednesday before Good Friday until sunrise on the Tuesday after Easter Monday.

13.6 Long Weekend Curfews

13.6.1 A RAV exceeding 2.7 metres in width and/or 30 metres in length must not travel on Forrest Highway and Lakelands Lake Clifton Road (includes Mandurah and Dawesville Bypasses), between the intersections of Pinjarra Road and Peppermint Grove Road, (Refer to the [Appendix 3 – Mandurah Curfew Map](#)), during the following periods:

- (a) Sunset on the Thursday prior to a Monday long weekend until sunrise on the Tuesday after a Monday long weekend; and
- (b) Sunset on the Wednesday prior to a Friday long weekend until sunrise on the Monday after a Friday long weekend.

13.6.2 A RAV exceeding 6.5 metres in width and/or 40 metres in length must not travel within the Metropolitan Area on a Friday prior to a Monday long weekend.

14 APPENDICES

Appendix	Title
Appendix 1	Central Zones
Appendix 2	Metropolitan Area Curfew Map
Appendix 3	Mandurah Curfew Map
Appendix 4	Fremantle Port Precinct
Appendix 5	Minimum Pilot and Escort Requirements
Appendix 6	Henderson Industrial Estate
Appendix 7	Roads Approved for 3 in Convoy
Appendix 8	Roads Approved for 4 in Convoy

Appendix 1: Central Zones

Perth Central Zone Map

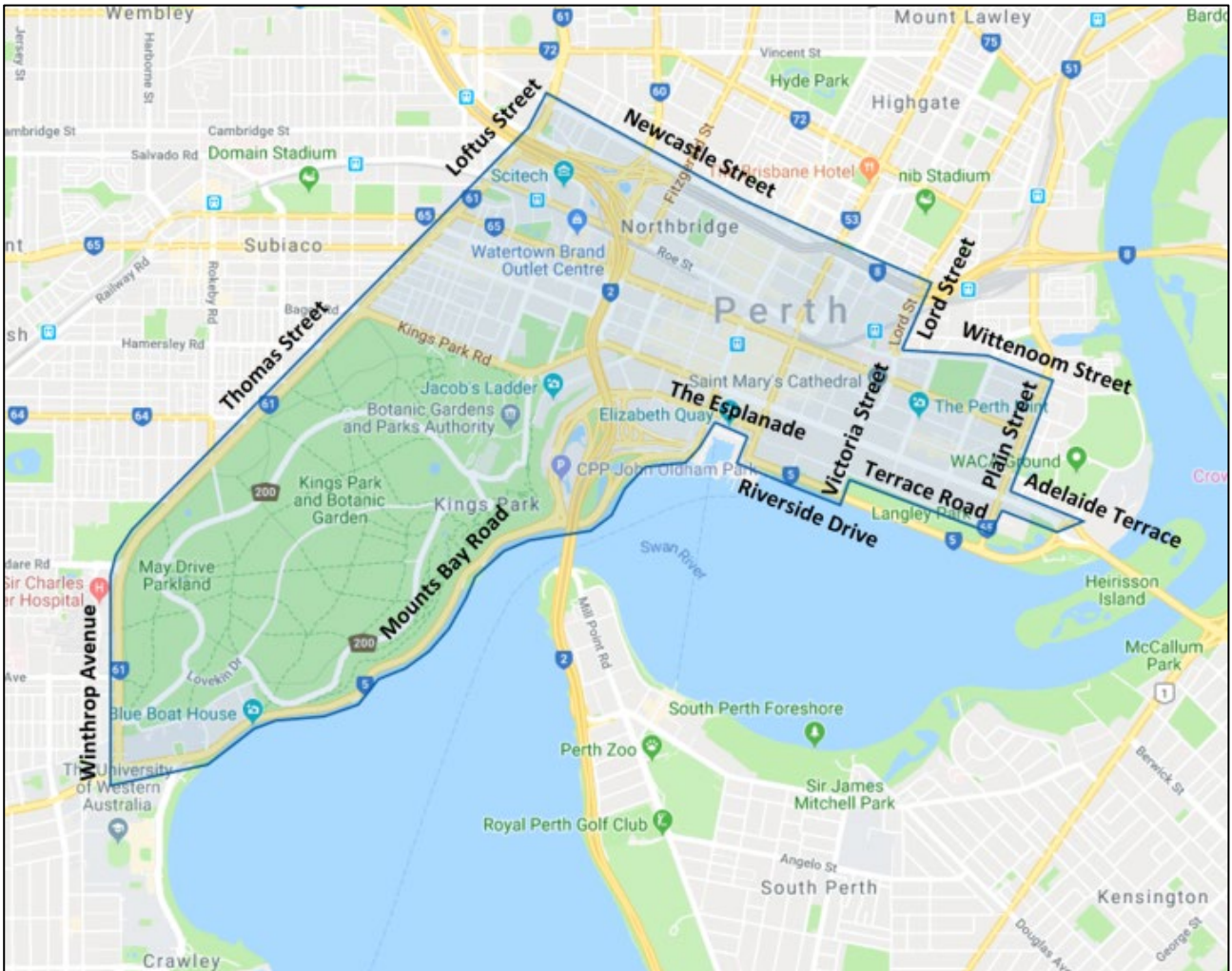

Fremantle Central Zone Map

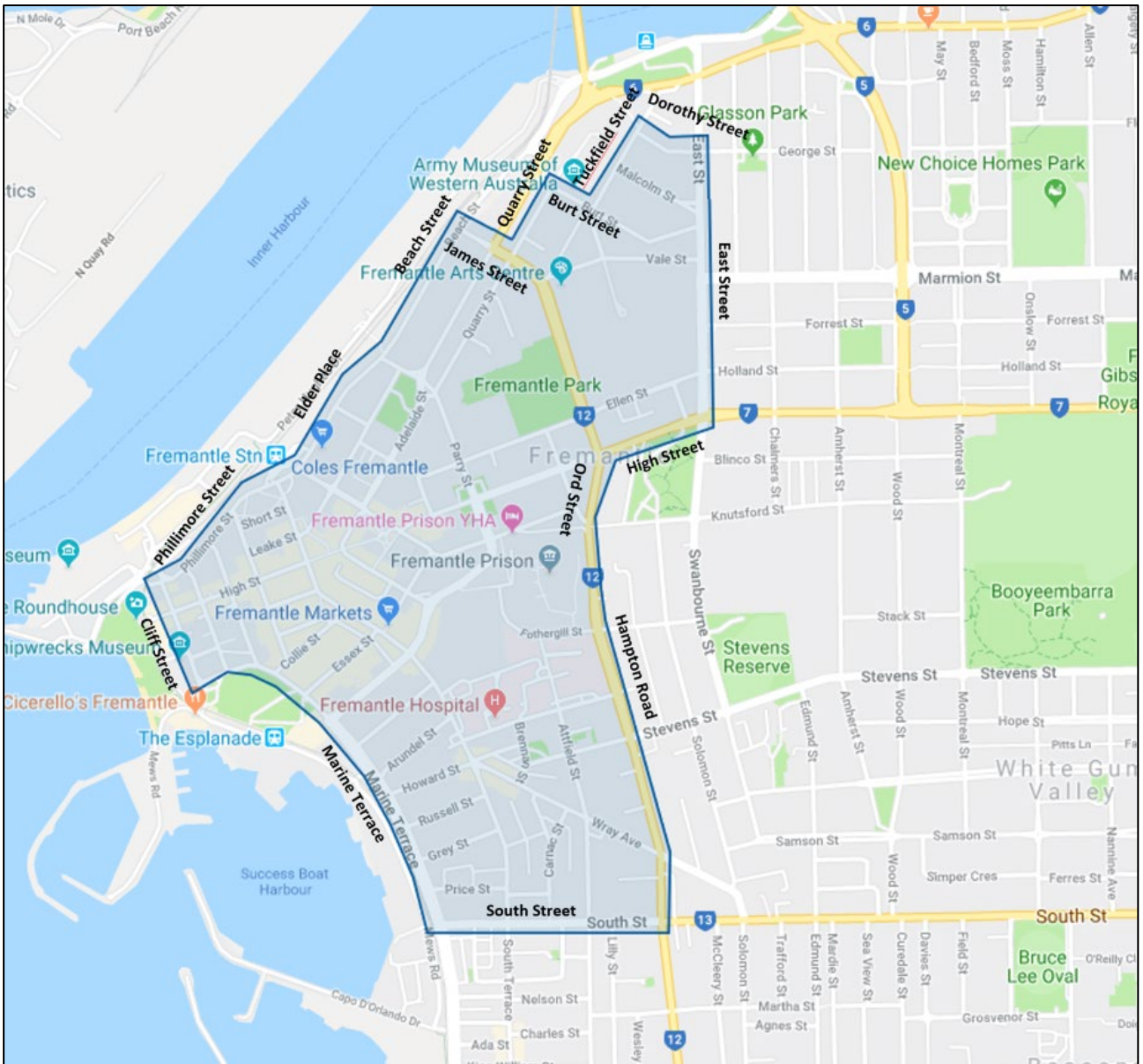

Appendix 2: Metropolitan Area Map

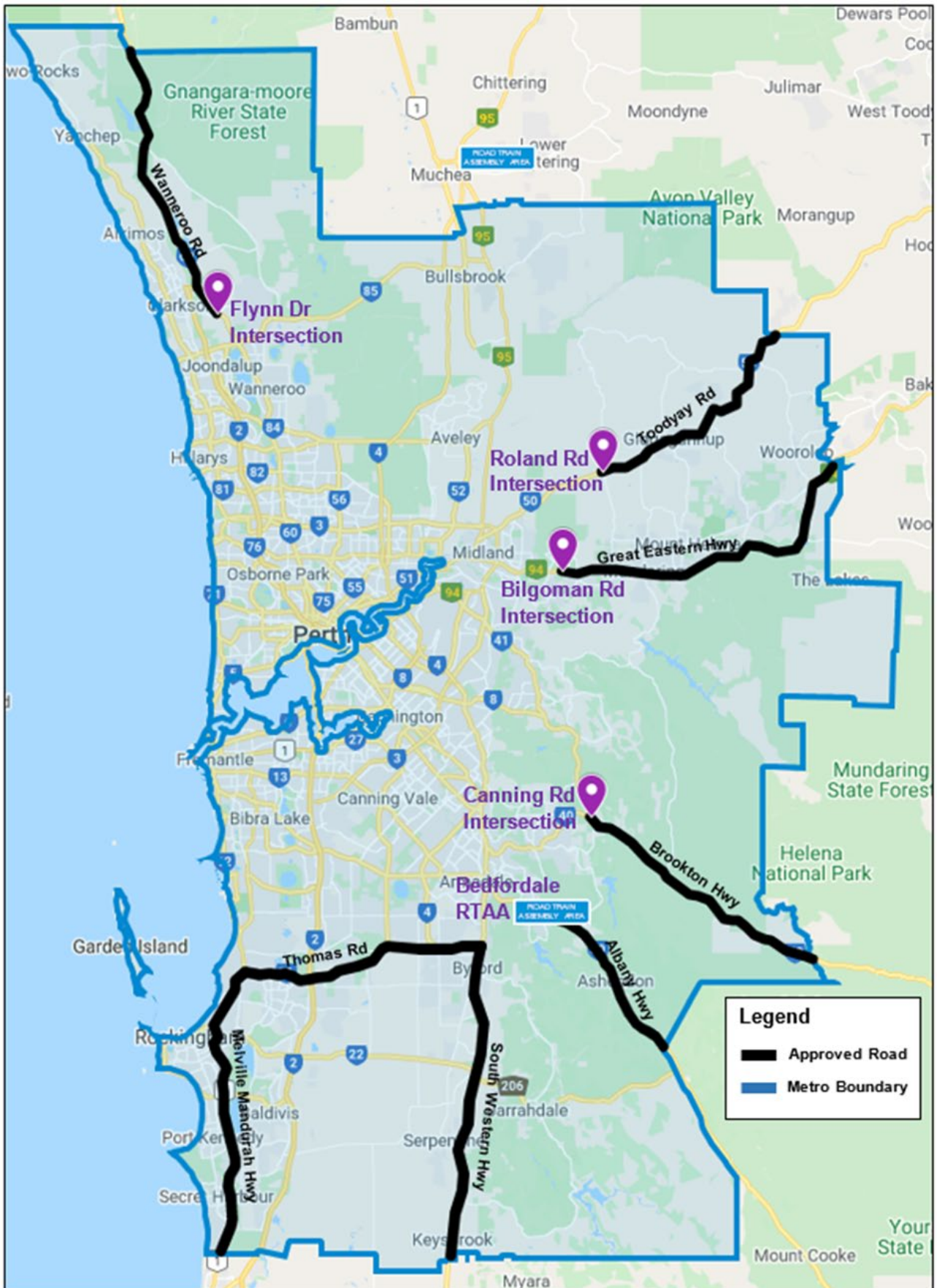

Appendix 3: Mandurah Curfew Map

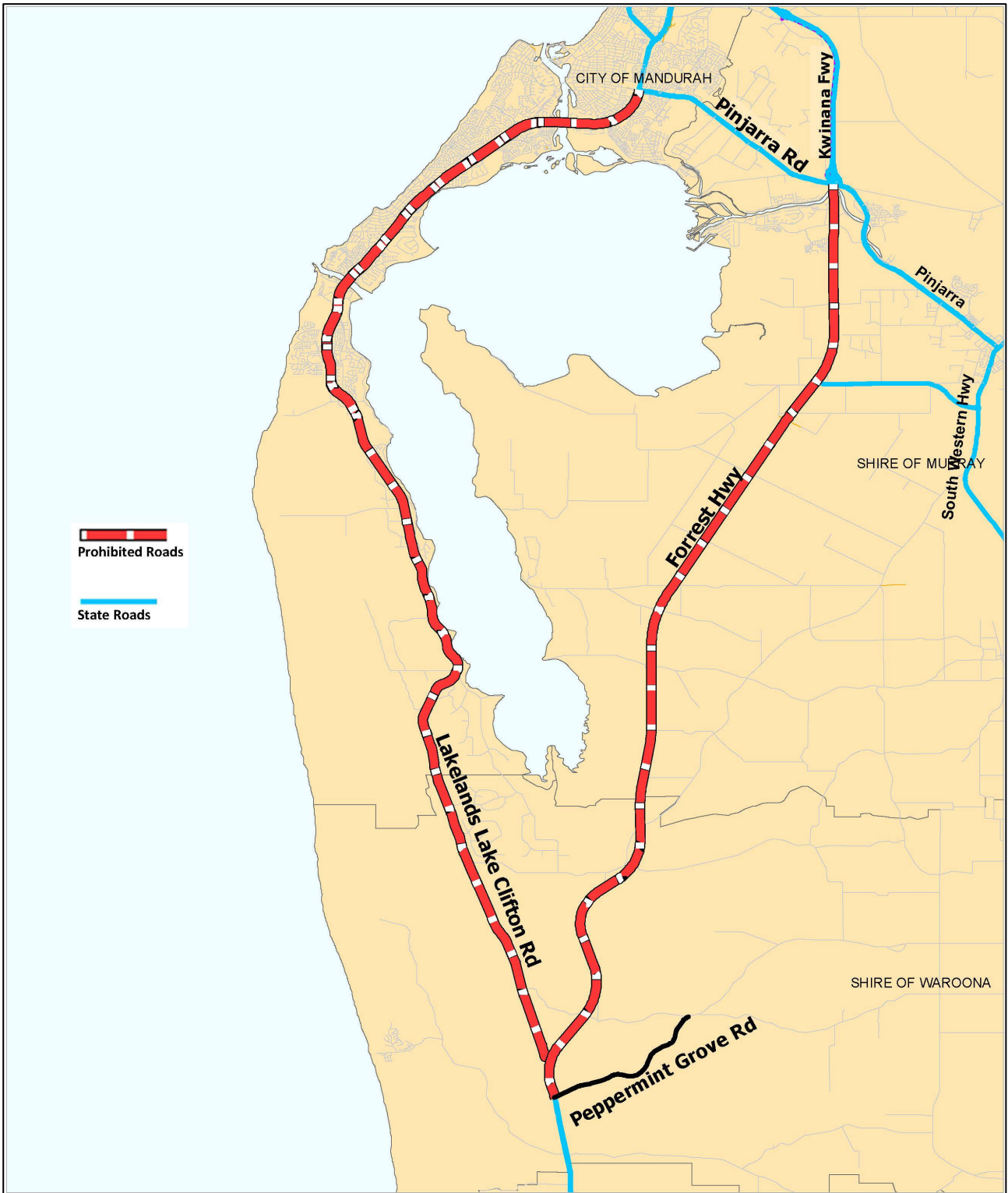

Appendix 4: Fremantle Port Precinct

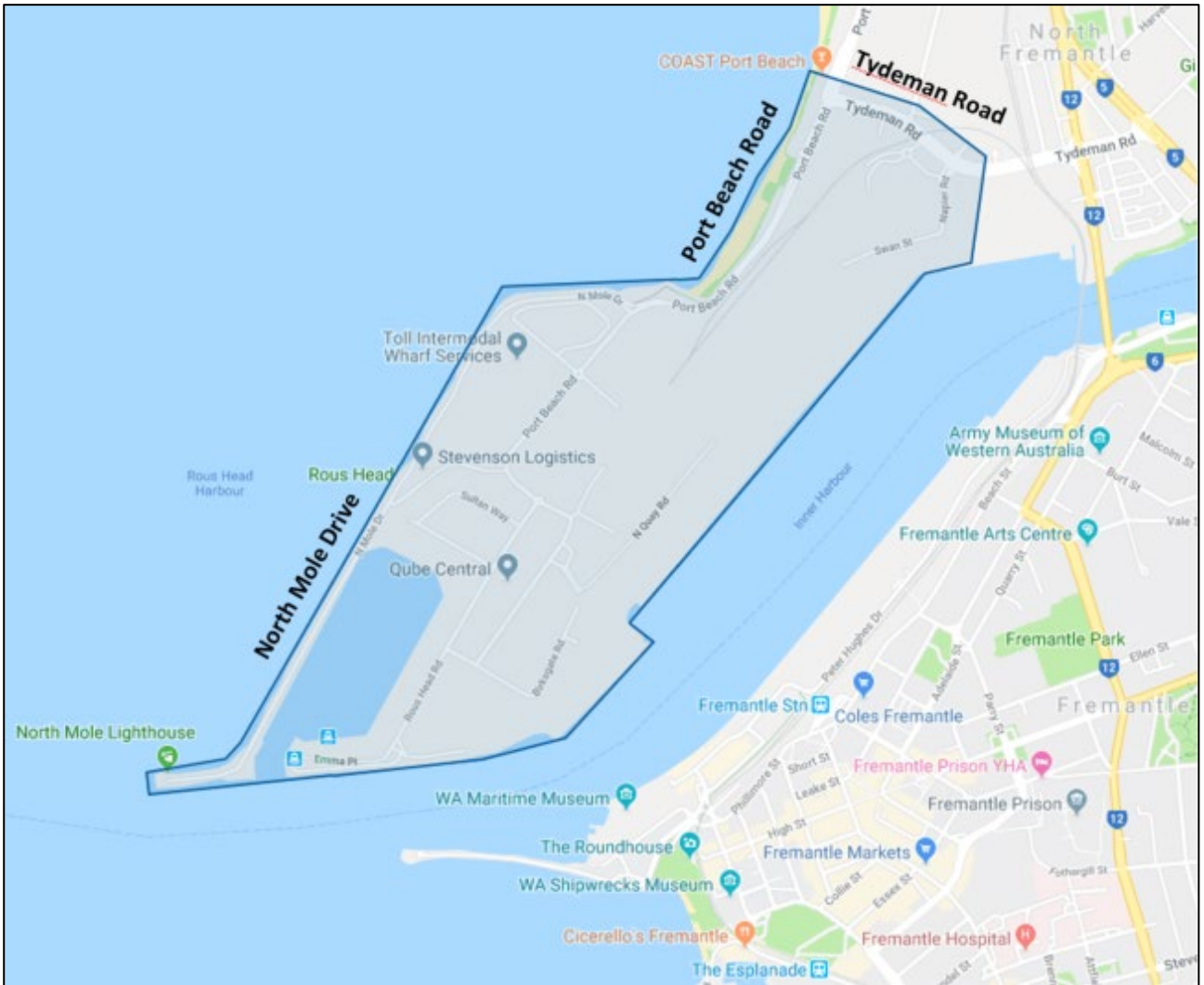

Appendix 5: Minimum Pilot & Escort Requirements

Minimum Pilot & Escort Requirements – Day Hours within Metropolitan Area (excluding Central Zones)

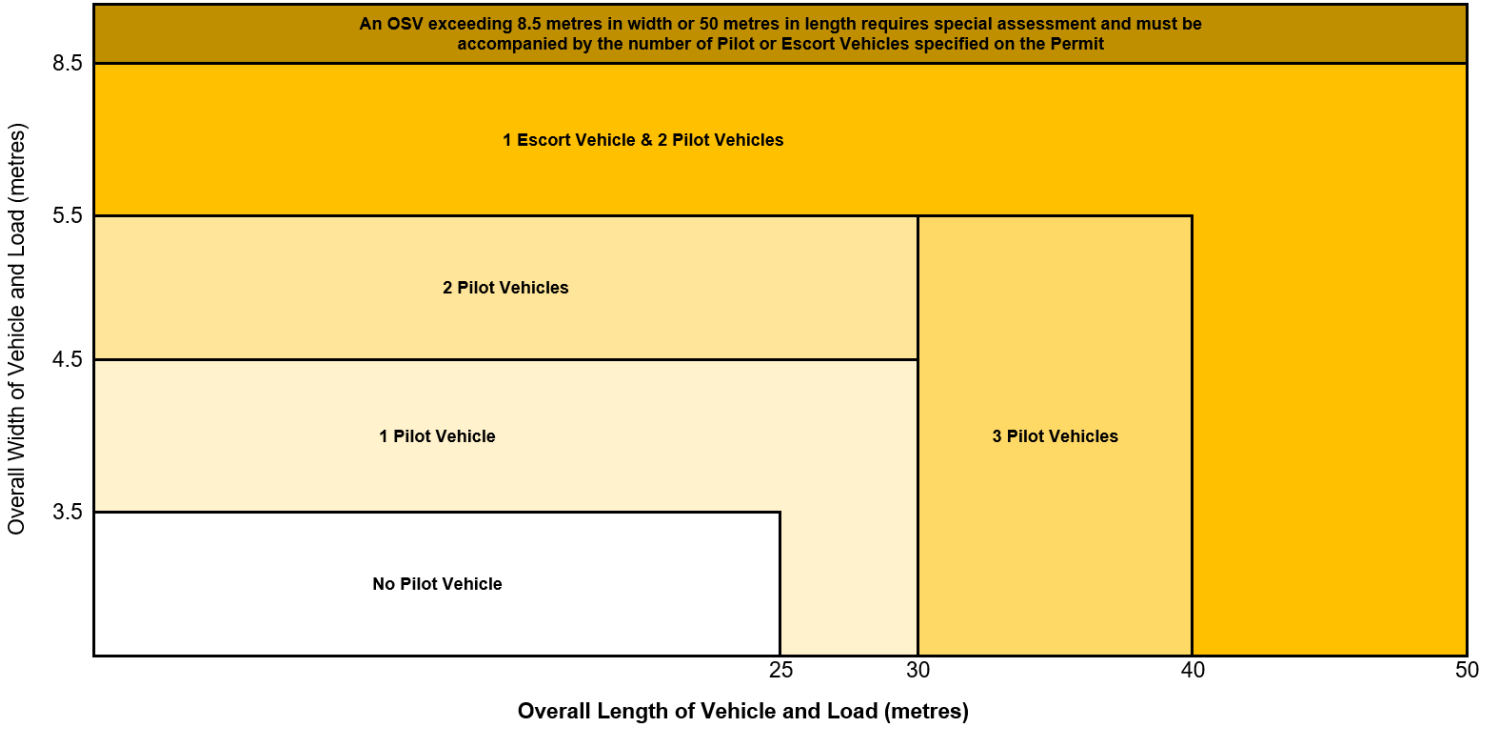

Minimum Pilot & Escort Requirements within Central Zones

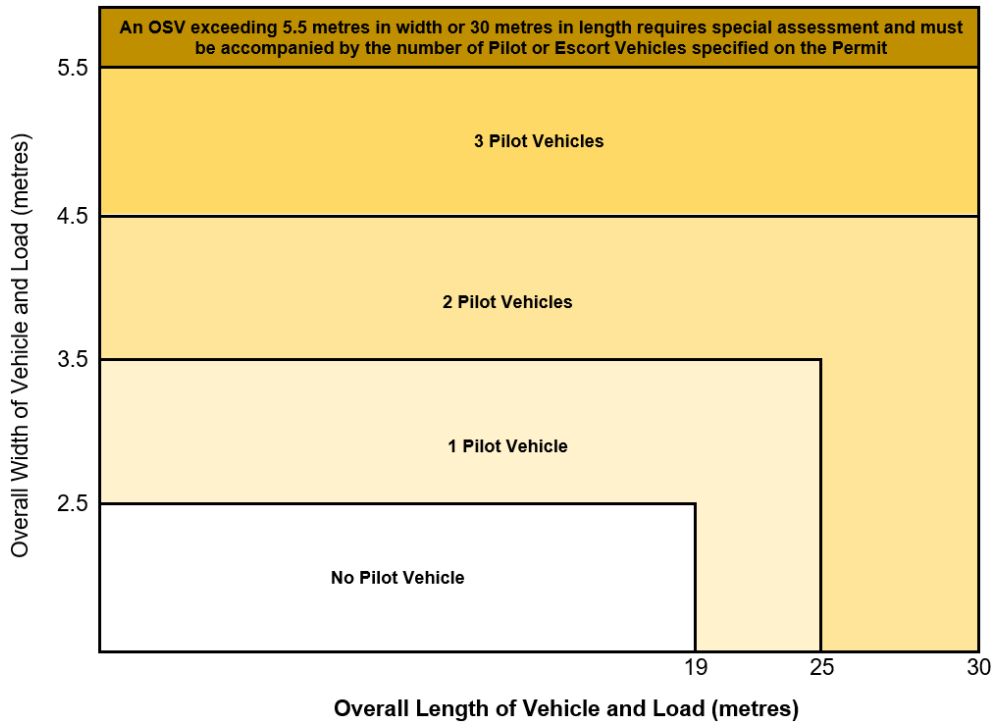

Minimum Pilot & Escort Requirements – Approved Night Hours within Metropolitan Area (excluding Central Zones)

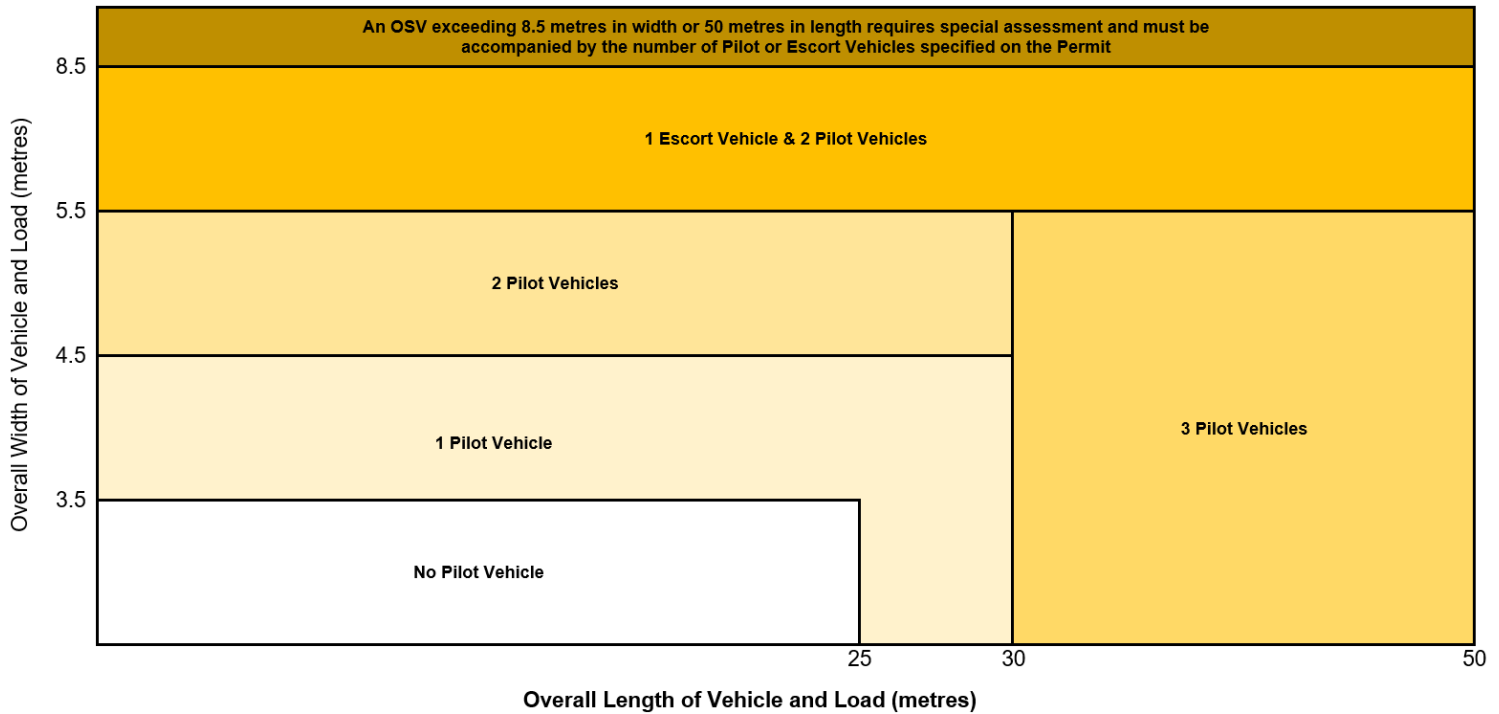

Note: For the purpose of the above table, “Approved Night Hours” are 9:30pm to 5:00am.

Minimum Pilot & Escort Requirements – Outside Metropolitan Area

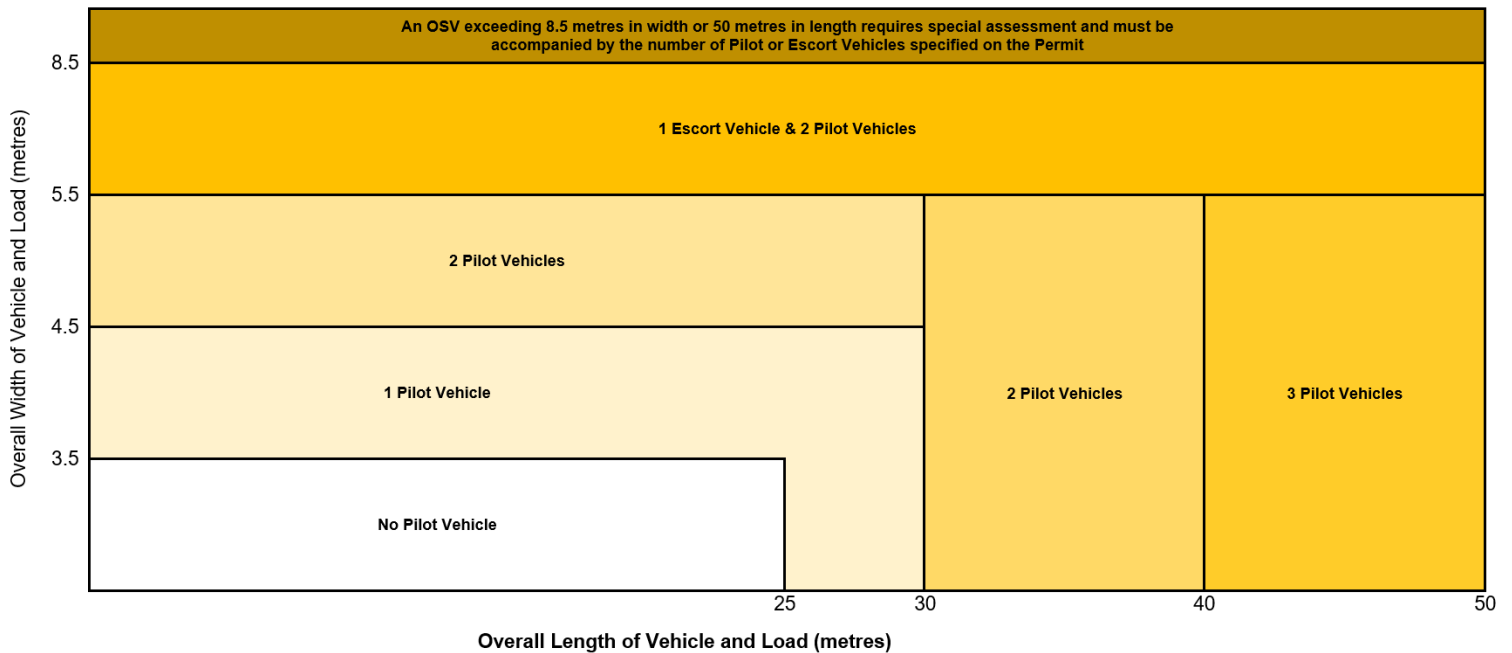

Appendix 6: Henderson Industrial Estate

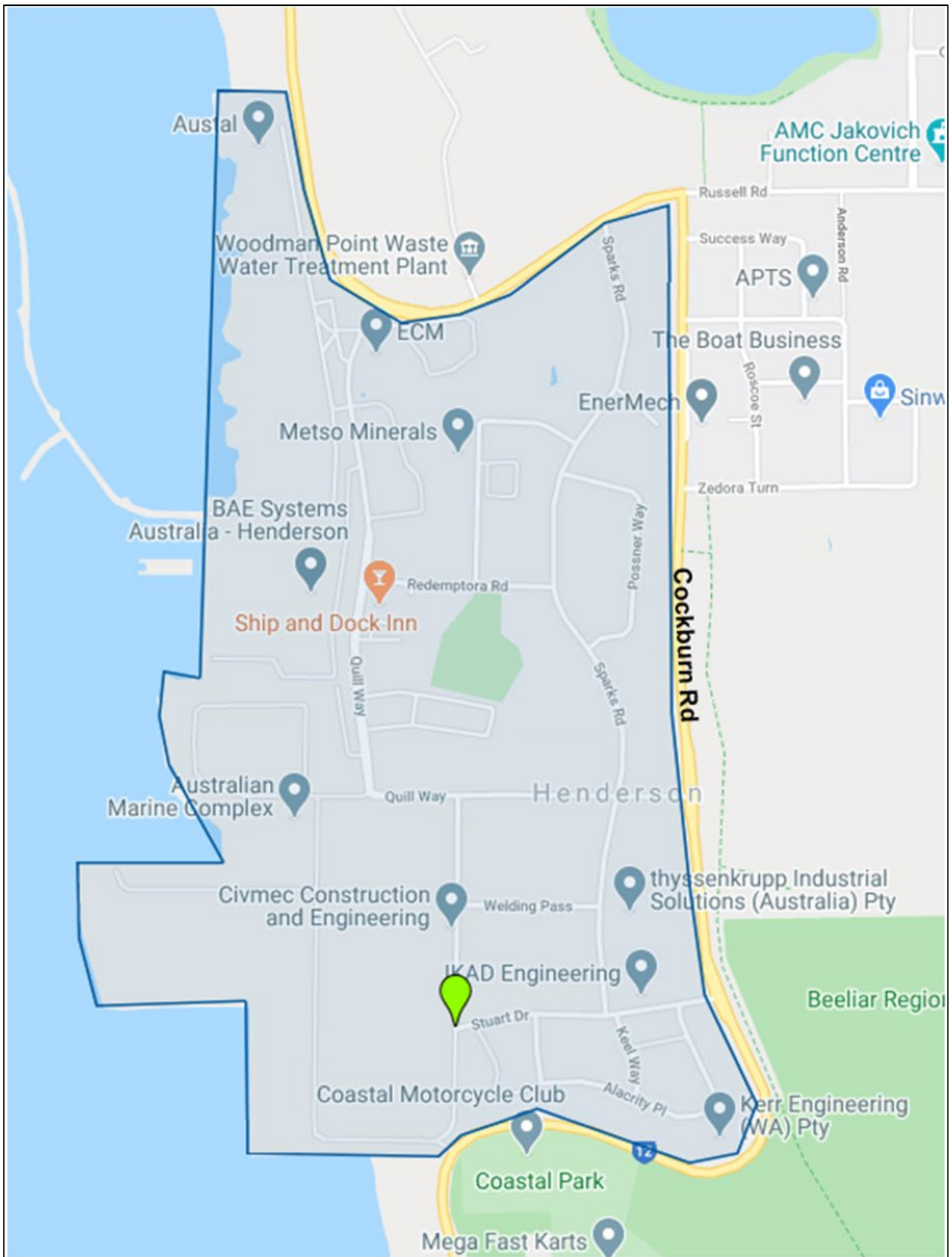

Appendix 7: Roads Approved for 3 in Convoy

The following roads are approved for 3 RAVs to travel in convoy:

Road Name	Road Number	Local Government	From	To
Bandya Rd	6070009	Laverton	Garden Well Mine Site	Lancefield Diversion Rd
Bell St	8130298	Port Hedland	Great Northern Hwy	SLK 0.40
Goldfields Hwy	H049	Leonora	Leonora Laverton Rd	Mt Magnet Leinster Rd
Great Northern Hwy	H006	Various	Wubin	Wyndham
Hamersley Rd	8110038	Ashburton	Nanutarra Munjina Rd	Eliwana Mine Access
Lancefield Diversion Rd	6070110	Laverton	Bandya Rd	Leonora Laverton Rd
Leonora Laverton Rd	M022	Leonora / Laverton	Lancefield Diversion Rd	Goldfields Hwy
Marble Bar Road	M030	East Pilbara	Munjina Roy Hill Rd	Roy Hill, Christmas Creek & Cloudbreak Mine Access
Mt Magnet Leinster Rd	M069	Leonora / Sandstone / Mt Magnet	Goldfields Hwy	Great Northern Hwy
Munjina Roy Hill Rd	8120232	East Pilbara	Great Northern Hwy	Marble Bar Rd
Nanutarra Munjina Rd	M029	Ashburton	Great Northern Hwy	Hamersley Rd
Pippingarra Access Rd	812Z024	East Pilbara	Wodgina Access Rd	Mine Access
Port Hedland Rd	H051	Port Hedland	Great Northern Hwy	Wedge St
Wodgina Access Rd	8120059	East Pilbara	Great Northern Hwy	Pippingarra Access Rd

Appendix 8: Road Approved for 4 in Convoy

The following roads are approved for 4 RAVs to travel in convoy:

Road Name	Road Number	Local Government	From	To
Bandya Rd	6070009	Laverton	Garden Well Mine Site	Lancefield Diversion Rd
Bell St	8130298	Port Hedland	Great Northern Hwy	SLK 0.40
Goldfields Hwy	H049	Leonora	Leonora Laverton Rd	Mt Magnet Leinster Rd
Great Northern Hwy	H006	Various	Mt Magnet	Wyndham
Hamersley Rd	8110038	Ashburton	Nanutarra Munjina Rd	Eliwana Mine Access
Lancefield Diversion Rd	6070110	Laverton	Bandya Rd	Leonora Laverton Rd
Leonora Laverton Rd	M022	Leonora / Laverton	Lancefield Diversion Rd	Goldfields Hwy
Marble Bar Road	M030	East Pilbara	Munjina Roy Hill Rd	Roy Hill, Christmas Creek & Cloudbreak Mine Access
Mt Magnet Leinster Rd	M069	Leonora / Sandstone / Mt Magnet	Goldfields Hwy	Great Northern Hwy
Munjina Roy Hill Rd	8120232	East Pilbara	Great Northern Hwy	Marble Bar Rd
Nanutarra Munjina Rd	M029	Ashburton	Great Northern Hwy	Hamersley Rd
Port Hedland Rd	H051	Port Hedland	Great Northern Hwy	Wedge St