



mainroads
WESTERN AUSTRALIA

*We're working for
Western Australia.*

Operating Conditions

Restricted Access Vehicles
Truck, Trailer Combinations

Printed copies are uncontrolled unless marked otherwise.
Refer to the Main Roads Website for current version.

D12#365480
October 2020

Contents

DEFINITIONS	4
1 APPLICATION	6
1.1 Approved Vehicles	6
1.2 Approved Axle Configuration	7
1.3 Operating in Conjunction with another Permit or Order	7
2 USING A NON-COMPLYING VEHICLE	8
2.1 Obtaining Exemptions or Modifications	8
2.2 Accepted Non-Complying Vehicles	8
3 COMPULSORY WA HEAVY VEHICLE ACCREDITATION	8
4 DIMENSION REQUIREMENTS	8
4.1 Length Limits	8
4.2 Height Requirements	9
4.3 Axle Spacings	9
4.4 Trailer Gap Requirements.....	10
5 MASS REQUIREMENTS	11
6 ACCESS REQUIREMENTS	11
6.1 Approved Roads and Conditions.....	11
6.2 Prohibited Roads	11
6.3 Low Volume Roads.....	11
6.4 Speed Restrictions.....	11
7 COMPULSORY HEAVY VEHICLE INCIDENT REPORTING	12
8 AMENDMENTS TO OPERATING CONDITONS & ACCESS	12
8.1 Access Approval Suspension & Revocation.....	12
8.2 Amendments & Notifications	12
9 APPENDICES	12
Appendix 1 – Low Volume Road Conditions	13

Document Control

Owner	Main Roads Heavy Vehicle Services
Custodian	Manager Heavy Vehicle Road Network Access
Document Number	D12#365480
Issue Date	13 October 2020
Review Frequency	As required.

Amendments

Revision Number	Revision Date	Description of Key Changes	Section / Page No.
1	14/05/2020	Updated document format.	All
2	03/08/2020	Changed name from RAV Networks to Tandem Drive Network	Pg. 4-5 Sections 1.1 and 4.2.4
3	13/10/2020	Added trailer gap requirements and updated Compulsory Heavy Vehicle Incident Reporting.	s. 4.4 & 7

DEFINITIONS

The following are definitions for terms used in these Operating Conditions. Refer to the definitions in the *Road Traffic (Administration) Act 2008* and the *Road Traffic (Vehicles) Act 2012* and any subsidiary legislation to these Acts for the meanings of any terms not defined in this section. If a definition in the relevant Acts or the subsidiary legislation conflicts with a definition in this section, the definition in this section prevails for the purpose of these Operating Conditions.

Term	Definition
Intermodal Container	A shipping container designed and built for intermodal freight transport.
Licensing Authority	A Government Authority responsible for the administration of the vehicle licensing provision of the law of the relevant State, Territory or the Commonwealth.
Livestock	Cattle, sheep, pigs or horses.
Low Volume Road	A rural Local Government road as set out in the latest version of the “ <i>Guidelines for Assessing the Suitability of Routes for Restricted Access Vehicles</i> ”, published on the Main Roads website.
Main Roads Website	www.mainroads.wa.gov.au
Non-complying Vehicle	A vehicle that does not comply with the vehicle standards and/or dimension requirements prescribed in the <i>Road Traffic (Vehicles) Regulations 2014</i> .
Order	The Order that is published in the Gazette subject to these Operating Conditions, under the provisions of Part 4 of the <i>Road Traffic (Vehicles) Act 2012</i> , which these Operating Conditions form part of.
Permit	Means a permit issued under Part 4 of the <i>Road Traffic (Vehicles) Act 2012</i> , which these Operating Conditions form part of.
Permit Holder	The Operator to whom the permit is issued.
Posted Speed Limit	The speed limit indicated by the numerals on the speed limit sign or 50 kilometres per hour in the absence of a speed limit sign in a built-up area.
Prime Mover	A motor vehicle built primarily to tow a semi-trailer, but does not include a truck or modified prime mover built primarily to carry a load or carry out a function other than towing a semi-trailer.
RAV	An approved vehicle combination to which the “ <i>Class 2 and 3 Prime Mover, Trailer Combinations Order 2017</i> ” applies.
Rear Overhang	The distance between the rear overhang line and the rearmost part of the vehicle or the load.
Rear Overhang Line	The centre of a single axle, single axle group, tandem axle group, tri axle group or quad axle group nearest to the rear of the vehicle.
Statutory Mass Limits	The mass limits prescribed in Part 8 of the <i>Road Traffic (Vehicles) Regulations 2014</i> .
Tandem Drive Network 1	The Tandem Drive Network 1 prohibited roads are published in the form of Road Tables or are available on the RAV Mapping Tool on the Main Roads website.

Term	Definition
Tandem Drive Network 2	The Tandem Drive Network 2 approved roads are published in the form of Road Tables or are available on the RAV Mapping Tool on the Main Roads website.
Tandem Drive Network 7	The Tandem Drive Network 7 approved roads are published in the form of Road Tables or are available on the RAV Mapping Tool on the Main Roads website.
Tandem Drive Network 8	The Tandem Drive Network 8 approved roads are published in the form of Road Tables or are available on the RAV Mapping Tool on the Main Roads website.
Tow Coupling Underrun	The distance the pivot point of a coupling is forward of the rear of the trailer to which it is attached.
Truck	A motor vehicle designed primarily for the carriage of goods directly upon it, and does not include a prime mover, unless it is fitted with a block for use as a block truck, or has been modified to the extent where its primary function is no longer to tow a semi-trailer.

1 APPLICATION

1.1 Approved Vehicles

1.1.1 The *Class 2 and 3 Truck, Trailer Combinations Order 2017* applies to a RAV in the following table:

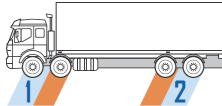
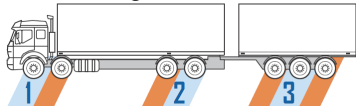
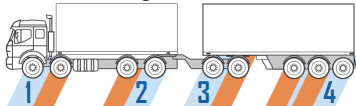
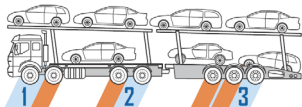
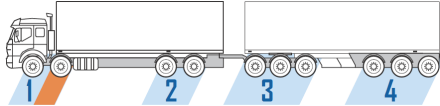
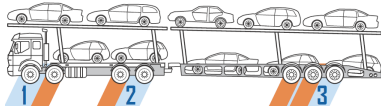
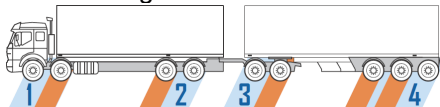
Category 1 RAVs				
Category	Vehicle Description	Length	Max. Mass	Approved Network
1A	Rigid Truck 	≤12.5 m	28.5 t	Tandem Drive Network 1
1B	Truck & Pig Trailer 	≤20 m	46.5 t	Tandem Drive Network 1
1C	Truck & Dog Trailer 	≤20 m	50 t	Tandem Drive Network 1
1D	Car Carrier Truck & Trailer 	≤20 m	46.5 t	Tandem Drive Network 1
Category 2 RAVs				
Category	Vehicle Description	Length	Max. Mass	Approved Network
2A	Truck & 6 Axle Dog Trailer 	≤25 m	68.5 t	Tandem Drive Network 2
2B	Car Carrier Truck & Trailer 	≤25 m	46.5 t	Tandem Drive Network 2
2C	Truck & Dog Trailer 	≤25 m	65 t	Tandem Drive Network 2
Category 3 RAVs				
Category 3 RAVs consist of Prime Mover, Trailer Combinations only. Refer to the Prime Mover, Trailer Combinations Operating Conditions.				
Category 4 RAVs				
Category 4 RAVs consist of Prime Mover, Trailer Combinations only. Refer to the Prime Mover, Trailer Combinations Operating Conditions.				
Category 5 RAVs				
Category 5 RAVs consist of Prime Mover, Trailer Combinations only. Refer to the Prime Mover, Trailer Combinations Operating Conditions.				

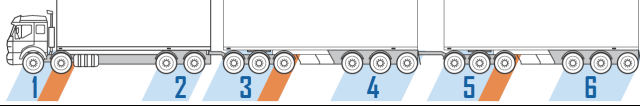
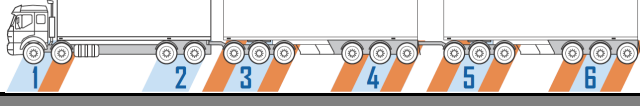
Category 6 RAVs				
Category 6 RAVs consist of Prime Mover, Trailer Combinations only. Refer to the Prime Mover, Trailer Combinations Operating Conditions.				
Category 7 RAVs				
Category	Vehicle Description	Length	Max. Mass	Approved Network
7B	Truck & Two 5 or 6 Axle Dog Trailers 	>27.5 m ≤36.5 m	108.5 t	Tandem Drive Network 7
Category 8 RAVs				
Category	Vehicle Description	Length	Max. Mass	Approved Network
8A	Truck & Two Dog Trailers 	>27.5 m ≤36.5 m	108.5 t	Tandem Drive Network 8
Category 9 RAVs				
Category 9 RAVs consist of Prime Mover, Trailer Combinations only. Refer to the Prime Mover, Trailer Combinations Operating Conditions.				
Category 10 RAVs				
Category 10 RAVs consist of Prime Mover, Trailer Combinations only. Refer to the Prime Mover, Trailer Combinations Operating Conditions.				

1.2 Approved Axle Configuration

1.2.1 The axle groups of a RAV described in Clause 1.1 are colour coded to indicate the minimum and maximum number of axles allowable for that category of vehicle, as shown below:



1.2.2 The *Class 2 and 3 Truck, Trailer Combinations Order 2017* does not apply to a RAV with less than the number of axles indicated.

1.2.3 The *Class 2 and 3 Truck, Trailer Combinations Order 2017* does not apply to a RAV with more than the number of axles indicated.

1.3 Operating in Conjunction with another Permit or Order

The *Class 2 and 3 Truck, Trailer Combinations Order 2017* cannot be used in conjunction with another permit or order.

2 USING A NON-COMPLYING VEHICLE

2.1 Obtaining Exemptions or Modifications

A RAV may consist of a non-complying vehicle mentioned in Clause 2.2, provided the relevant licensing authority has issued the necessary vehicle standards exemption or dimension modification.

2.2 Accepted Non-Complying Vehicles

2.2.1 A semi-trailer with a non-complying length may be used, provided:

- (a) The semi-trailer does not exceed 14.63 metres in length; and
- (b) The semi-trailer does not exceed 9.5 metres from the king pin to the centre of rear axle group; and
- (c) The semi-trailer does not exceed 13.2 metres from the king pin to the rear of the trailer; and
- (d) The front of the semi-trailer forward of the king pin does not exceed 1.43 metres or a radius of 1.9 metres; and
- (e) The semi-trailer is used as the rearmost trailer in the vehicle combination.

2.2.2 A semi-trailer with a non-complying tow coupling underrun may be used, provided:

- (a) The distance from the rearmost part of the semi-trailer or load, to the forward most part of the following semi-trailer or load, is not less than 1270 millimetres; or
- (b) Specific approval is obtain from Main Roads Heavy Vehicle Services.

2.2.3 A dolly with a non-complying drawbar height may be used, provided:

- (a) The drawbar is level when the combination is parked on level ground. For the purpose of this sub-clause, level means no more than 100 millimetres height difference between the drawbar ends; or
- (b) The drawbar is a gooseneck drawbar.

2.2.4 A dolly with a drawbar that exceeds the maximum prescribed length may be used, provided:

- (a) The dolly has a gooseneck drawbar; and
- (b) The front of the drawbar is connected more than 300 millimetres forward of the rear of the leading trailer.

3 COMPULSORY WA HEAVY VEHICLE ACCREDITATION

The operator or permit holder must be accredited under the WA Heavy Vehicle Accreditation Scheme (WAHVAS).

4 DIMENSION REQUIREMENTS

4.1 Length Limits

4.1.1 A RAV must not exceed the maximum length indicated for the particular vehicle category in Clause 1.1.

4.2 Height Requirements

- 4.2.1** A RAV must not exceed a height of 4.3 metres, unless otherwise specified in this sub-clause 4.2.2.
- 4.2.2** A Category 1 and 2 RAV may operate with a height up to 4.6 metres, provided the excess height is on:
- (a) A rigid truck and/or semi-trailer built to carry livestock; or
 - (b) A rigid truck and/or semi-trailer carrying a crate built to carry livestock; or
 - (c) A car carrier rigid truck and/or car carrier trailer carrying vehicles on more than one deck; or
 - (d) A rigid truck and/or semi-trailer carrying an intermodal container.
- 4.2.3** A pig trailer must not exceed a height of 3.5 metres, including any load.
- 4.2.4** A RAV exceeding 4.3 metres in height must not be driven on a road without current written approval from all the relevant Cable Operators, unless the height is less than 4.6 metres and the vehicle is being driven on a road that is listed in Tandem Drive Network 2. The written approval must be carried in the RAV and produced upon request.

Note: “Contact Details for Other Agency Approvals” are available on the Oversize Over-mass Permits page on the Main Roads website.

4.3 Axle Spacings

- 4.3.1** A RAV must comply with the minimum axle spacing requirements specified in the following table:

Table A

Adjacent Axles or Axle Groups	Minimum Distance
Single axle to single axle	2.5 m
Single axle to tandem axle group	4.3 m
Single axle to tri axle group	5.5 m
Tandem axle group to tandem axle group	6.8 m
Tandem axle group to tri axle group	8.0 m
Tri axle group to tri axle group	9.2 m

- 4.3.2** Despite sub-clause 4.3.1, a Category 1C and 2C RAV may comply with the minimum axle spacing requirements specified in the following table:

Table B

Adjacent Axles or Axle Groups	Minimum Distance
Single axle to single axle	2.5 m
Single axle to tandem axle group	4.3 m
Single axle to tri axle group	5.5 m
Tandem axle group to tandem axle group	5.6 m
Tandem axle group to tri axle group	6.9 m

Axle spacing measurements are taken from the outmost extreme axles of the two adjacent axle groups, as shown below:

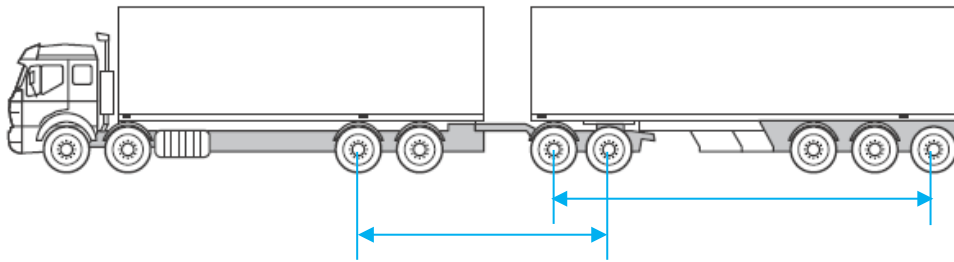

“Single Axle” does not include a single steer axle.
 “Tandem axle group” does not include a twin steer axle group.

4.4 Trailer Gap Requirements

4.4.1 The RAV must be able to achieve the following angles of rotation simultaneously and independently, without any part of the trailer contacting any part of the towing vehicle (i.e. prime mover, lead semi-trailer or converter dolly), including the load:

- (a) Articulation – 45° left and right;
- (b) Pitch – 6° forward and 7° rearward;
- (c) Roll – as provided by the coupling.

4.4.2 There must be sufficient clear gap, as per the below example to achieve the specified angles of rotation:

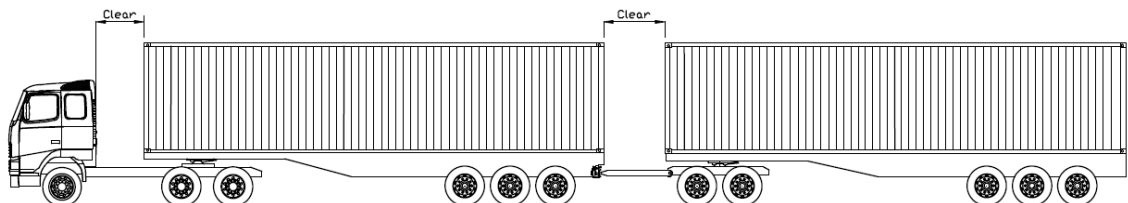

4.4.3 The clear gap must be sufficient to enable the trailers to move through all the specified angles of rotation without contacting any other part of the towing vehicles, as per the following two diagrams. The red circles indicate the potential fouling zones.

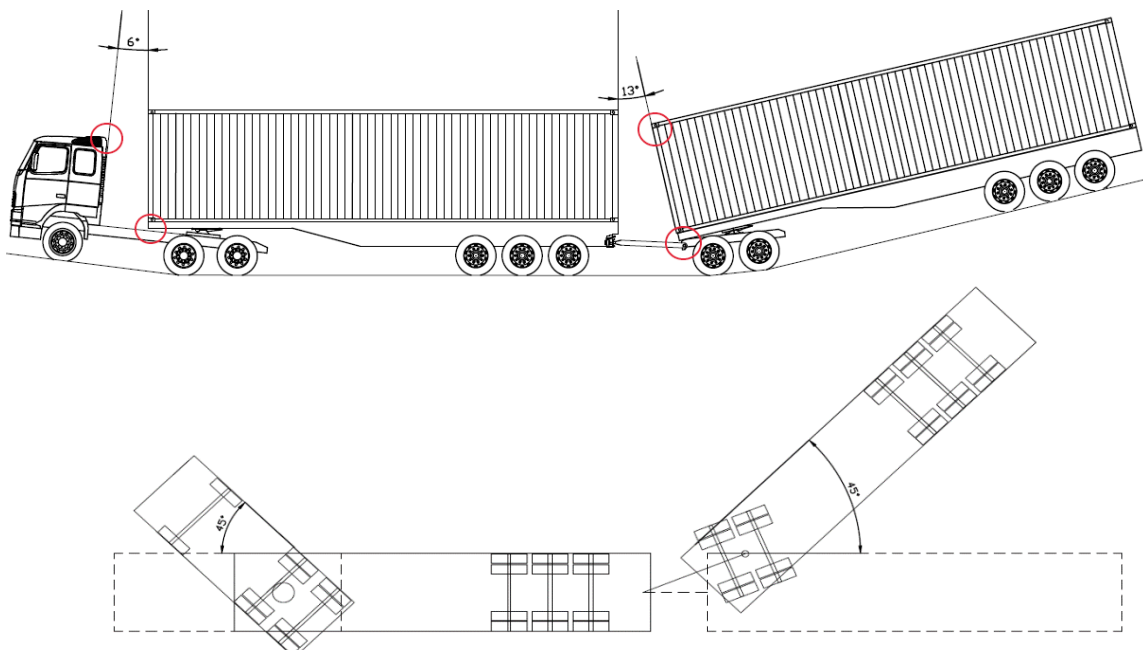

5 MASS REQUIREMENTS

5.1.1 A RAV must not exceed the maximum mass indicated for the particular vehicle category in Clause 1.1.

5.1.2 A RAV is not permitted to exceed any statutory mass limit relating to an axle or axle group, except where specified in the following table:

Axle Group	Mass Limit
Single Steer Axle with tyres <375 mm	6.5 t
Single Steer Axle with tyres ≥375 mm	7 t
Twin Steer Axle Group with non-load sharing suspension	10 t
Twin Steer Axle Group with load sharing suspension and tyres <375 mm	11 t
Twin Steer Axle Group with load sharing suspension and tyres ≥375 mm	12 t

5.1.3 A block truck used in a RAV must have at least 14 tonnes on the tandem drive axle group.

Note: The maximum mass indicated in Clause 1.1 is based on a twin steer axle with 12 tonnes.

6 ACCESS REQUIREMENTS

6.1 Approved Roads and Conditions

6.1.1 A RAV must not operate on any road that is not in the Approved Network specified for the particular vehicle category in Clause 1.1.

6.1.2 A RAV must operate in accordance with any conditions specified for a particular road in the Approved Network.

6.2 Prohibited Roads

A RAV in excess of 4.3 metres in height must not operate on Mitchell Freeway and Kwinana Freeway, between Powis Street and Leach Highway.

6.3 Low Volume Roads

Roads identified in the Approved Network as “low volume” do not strictly meet the minimum road width requirements. However, these roads have been approved for RAV access due to the low traffic volumes. In addition to any conditions specified for a particular road in the Approved Network, a RAV must comply with the Low Volume Road Conditions specified in [Appendix 1](#).

6.4 Speed Restrictions

Unless otherwise specified as a condition for a particular road in the Approved Network, a RAV must not travel at a speed exceeding 10 km/h lower than the posted speed limit, where the posted speed limit is greater than 60 km/h.

7 COMPULSORY HEAVY VEHICLE INCIDENT REPORTING

All on-road incidents involving a RAV must be reported to Main Roads Heavy Vehicle Services by the permit holder. The Heavy Vehicle Incident Reporting form is available on the Incident Reporting page on the Main Roads website and it must be submitted within 48 hours of the incident occurring.

8 AMENDMENTS TO OPERATING CONDITONS & ACCESS

8.1 Access Approval Suspension & Revocation

8.1.1 Approval to operate a RAV may be suspended when road and/or traffic conditions are considered unsuitable. Main Roads personnel, WA Police or Traffic Escort Wardens, may make verbal notification of such suspension.

8.1.2 Approval to operate a RAV may be suspended or revoked if the operator or vehicle combination fails to comply with any of the requirements specified in these Operating Conditions.

8.2 Amendments & Notifications

8.2.1 These Operating Conditions are subject to occasional amendments. If amendments are made that impact transport operators, they will be published as an “HVS Update” on the Main Roads website on the first working day of the month. Operators and drivers are required to ensure that they are operating vehicles on the public road network in accordance with the current and up to date Operating Conditions.

8.2.2 The RAV Networks are subject to periodic amendments, which include additional roads being included in the lists, roads being removed from the lists, or amendments being made to a condition relating to a particular road in the lists. RAV Network updates will be effective from the Wednesday following the amendment and the RAV Networks are maintained on the Main Roads website. Operators and drivers are required to ensure they are operating vehicles on the public road network in accordance with the current and up to date RAV Networks.

8.2.3 Heavy Vehicle Travel Impacts are published when road conditions may impede the movement of Restricted Access Vehicles. Operators and drivers are required to check the Heavy Vehicle Travel Impacts page on the Main Roads website prior to operating the vehicle on the public road network to ensure that there is no relevant information that will impede their vehicle operating on the WA road network.

8.2.4 All conditions stipulated in HVS Updates or Heavy Vehicle Travel Impacts must be adhered to.

9 APPENDICES

Appendix	Title
Appendix 1	Low Volume Road Conditions

Appendix 1 – Low Volume Road Conditions

“Type A” Low Volume Roads:

- (a) Current written approval from the road owner, endorsing use of the road, must be obtained, carried in the vehicle and produced upon request; and
- (b) Operation is not permitted while the school bus is operating on the particular road. Operators must contact the relevant schools directly for school bus timetables; or where direct contact can be made with the school bus driver, operation is permitted once the school bus driver confirms all school drop-offs / pick-ups have been completed on the particular road; and
- (c) Headlights must be switched on at all times; and
- (d) When travelling at night, the RAV must travel at a maximum speed of 40km/h and display an amber flashing warning light on the towing vehicle; and
- (e) No operation on unsealed road segment when visibly wet, without road owner’s approval; and
- (f) Direct radio contact must be maintained with other RAV’s to establish their position on or near the road (UHF channel 40).

“Type B” Low Volume Roads:

- (a) All conditions stipulated for “Type A” Low Volume roads apply; and
- (b) For a single lane road, the road must not to be entered until the driver has established via radio contact that there is no other RAV on the road travelling in the oncoming direction, and
- (c) The RAV must not exceed a speed of 40 km/h.