

Structures Engineering

Detailed Visual
Inspection Guidelines
for Culverts
(Level 2 Inspections)

Document No: 6706-02-2237

DETAILED VISUAL CULVERT INSPECTION GUIDELINES (Level 2 Inspections)

This information is owned and controlled by the Senior Engineer Structures. The Bridge Condition Manager is a delegated custodian. All comments and requests for changes are to be submitted to the delegated custodian.

AUTHORISATION

As head of Structures Engineering of Main Roads Western Australia,
I authorise the issue and use of this document.



R F SCANLON

SENIOR ENGINEER STRUCTURES

Date: 09/09/2010

Document No. 6706-02-2237

REVISION STATUS

Page No.	Revision No.	Revision Date	Revision Description	Approved By	Signature
All	1	06/01/12	General update and inclusion of information on confined spaces	R F Scanlon	

All controlled copies shall be marked accordingly

TABLE OF CONTENTS

1.0	INTRODUCTION	4
2.0	PURPOSE	5
3.0	OTHER REFERENCES.....	5
4.0	CULVERT INSPECTION PROCEDURE	6
5.0	CULVERT INVENTORY DATA.....	9
6.0	DETAILED VISUAL CULVERT INSPECTION FORM	15
7.0	TYPICAL WA CULVERT MATERIAL TYPES.....	18
8.0	COMMON MATERIAL DEFECTS.....	22
9.0	DEFECTS UNRELATED TO MATERIALS	25
10.0	SEVERITY LEVEL RATING	27
APPENDIX A:	CULVERT COMPONENTS AND TERMINOLOGY.....	45
APPENDIX B:	CULVERT DETAILED VISUAL INSPECTION REPORT (Level 2 Inspections) EXAMPLE – RC BOX CULVERT	48
APPENDIX C:	CULVERT DETAILED VISUAL INSPECTION REPORT (Level 2 Inspections) EXAMPLE – STEEL PIPE CULVERT.....	55
APPENDIX D:	SEVERITY LEVEL RATINGS	61

1.0 INTRODUCTION

A culvert is a structure under a road having only clear openings of less than or equal to three metres measured between the faces of piers and/or abutments and pipe shaped structures of any diameter.

Culverts are an important component of Main Roads Western Australia's (MRWA's) road network. Compared to bridges, culverts are smaller and less critical structures buried beneath the road embankment. However, failure of culverts can be a hazard to traffic. Excessive settlement or collapse can result in closure of the network. They constitute an asset that is subject to deterioration and therefore they must be managed appropriately. The total investment in culvert structures is considerable and comparable in value to bridges.

Large precast box culverts with clear openings greater than three metres are defined as a special category of bridge. Inspection of these bridge types is covered in *Condition Assessment - Level 2, Detailed Visual Bridge Inspection Guidelines for Concrete & Steel Bridges*, document no. 6706-02-2233.

This document details Level 2 culvert inspections and the assessment of condition of various culvert components. The management of inspections of culverts is documented in the *Structures Inspection & Information Management Policy*, document no. 6706-01-202.

MRWA is only responsible for the management of culverts on State Roads and National Highways. The detailed visual inspections of these culverts are the responsibility of the Region.

Routine visual culvert inspections (Level 1 inspections) are carried out by Regions at timeframes applicable to their culvert stock and environment. They are generally undertaken as a check for serviceability of the culvert against silting, scour and any other obvious visual defects.

This document outlines the next level of inspection (Level 2 inspections) for culverts which are also the responsibility of the asset owner. These detailed visual inspections are more in depth and are used to determine the condition of the asset, to obtain information on asset maintenance needs and to ensure that the inventory is kept up-to-date.

In some instances, particularly for the larger structures, the Inspector may require more detailed information than that obtained from close visual scrutiny to enable the assessment of level of risk to public safety or in determining a management strategy. In these cases engineering support or a more detailed structural special inspection and investigation (Level 3 inspections) may be appropriate. Specialist advice can be sought from Structures Engineering.

Documentation requirements generally entail completion of a pro-forma with comments on most aspects of the culvert's condition and includes photographs of anomalies. Data is generally qualitative in nature with a severity level assigned to the main culvert components.

2.0 PURPOSE

The purpose of this document is to provide an inspection procedure and a process for the Inspector to undertake Detailed Visual Inspections (Level 2 inspections) for culverts in a consistent manner and record the condition in a standardised manner. It will also assist in providing a consistent approach to the inventory data storage.

This document includes:

- The standard Culvert Detailed Visual Inspection Report (Level 2) form;
- Explanation of the terminology used in the Culvert Detailed Visual Inspection Report form; and
- Details of the type of information required to be collected in the form with guidance on what aspects need to be considered in inspecting each component of a culvert to enable a consistent approach in inspection and severity level rating.

3.0 OTHER REFERENCES

Other references relevant to this document are:

- *Structures Inspection & Information Management Policy*, document 6706-01-202 for definitions, general information, responsibilities and reference requirements for inspection types, general inspection procedures and material defect descriptions.
- *Condition Assessment - Level 2, Detailed Visual Bridge Inspection Guidelines for Timber Bridges*, document 6706-02-2231 and *Condition Assessment - Level 2, Detailed Visual Bridge Inspection Guidelines for Concrete and Steel Bridges*, document 6706-02-2233 to assist the Inspector further with assessing the severity level rating and for useful information on material defects.

4.0 CULVERT INSPECTION PROCEDURE

The culvert inspection process is essentially visual in nature. All defects need to be noted and photographed as they may be the first indications of underlying problems. Where the condition of critical components is not clear during the culvert detailed visual inspection, engineering support or further investigation (Level 3) may be necessary to confirm the condition and identify any problems. The need for additional inspections must be noted in the inspection report. Where there is no visible defect, the form shall be marked and completed appropriately.

4.1 Extent of Inspections

The scope of a Level 2 detailed visual inspection includes:

- inspection of delineation, waterways, walls and aprons, and culvert units;
- identification of work items; and
- recommendation of a special structural inspection and investigation if it is warranted by observed distress or unusual behaviour of the culvert.

Components that are not accessible are to be checked from as close as practicable with appropriate comments made on the inspection report forms indicating which components were not able to be inspected.

4.2 Frequency of Inspections

There are specific requirements for the management of culverts as outlined in the *Structures Inspection & Information Management Policy*. Typically culverts are of simple construction and defects can be readily detected. These defects provide a sound basis for assessing the culvert condition. The suitable inspection frequency is primarily a function of the material used in its construction.

A detailed visual culvert inspection should be undertaken at least every five years for timber culverts and every seven to ten years for culverts constructed using other materials. Regions are to establish a specific ongoing monitoring program for their assets with more frequent inspections for high risk culverts. These minimum inspection frequencies should be increased for specific culverts showing advanced signs of deterioration and if warranted by the more regular routine visual inspections.

4.3 Operational Safety

All inspection procedures and operations must comply with the relevant rules and regulations of the Occupational Safety and Health Act 1984 and appropriate MRWA operational safety guidelines and documents.

Where inspections are to be carried out on culverts located near the assets of other Authorities, the relevant regulations and Codes of Practice relating to work on or close to their assets must be adhered to. This is particularly important when inspecting culverts near railways.

If the Inspector plans to inspect a culvert in particularly poor condition but the culvert has not yet failed under traffic, it is recommended to close a lane and inspect half of the culvert at a time under no live loading. If the culvert is in critical, imminent failure condition and is generally poor throughout it is not considered safe nor warranted to undertake an inspection

in detail. Instead expert advice should be sought on the safe load carrying capacity and replacement planned as a priority.

At some culvert sites it may be difficult to find a safe parking location especially at sites on major roads and highways where the traffic volumes and speeds are high or where there is insufficient room within the roadside. It is important that the position of the Inspector's parked vehicle does not block road sight distances to motorists in both directions.

Access to all culvert components for inspection via embankments can potentially pose a safety risk to the Inspector due to steep embankments and loose surface material. Further information for guidance on the appropriate level or standard of access can be found in the document 'Design Guidelines for Access Requirements at Bridge Abutments' which is equally applicable to culverts.

4.4 Confined Spaces

The governing regulations for confined spaces are the 'Occupational Safety and Health Regulations 1996', Regulation 3.82 which provides a definition for how a 'confined space' is identified and these definitions are reproduced below:

"Confined space means an enclosed or partially enclosed space which -

- (a) is not intended or designed primarily as a workplace, and*
- (b) is at atmospheric pressure during occupancy, and*
- (c) has restricted means for entry and exit,*

and which either-

- (d) has an atmosphere containing or likely to contain potentially harmful levels of contaminant; or*
- (e) has or likely to have an unsafe oxygen level; or*
- (f) is of a nature or is likely to be of a nature that could contribute to a person in the space being overwhelmed by an unsafe atmosphere or a contaminant."*

In addition, these Regulations make reference to Australian Standard AS 2865 'Confined Spaces' with respect to work being done in a confined space. Note that AS 2865 also contains definitions of a confined space, however where there is a difference the Regulations will take precedent.

A number of culverts within Western Australia have an enclosed space that would be covered by the definitions (a), (b) and (c), however Structures Engineering with its knowledge of the State's infrastructure is unaware of a culvert space which meets the definitions (d), (e) or (f) of the Regulation. This means that there are no known culverts with a 'confined space' as defined in the Regulations.

However there are certain culverts where the access is difficult. In instances like these, the restricted access and confined space will be an additional component to consider when preparing for the inspection. The Inspector may be required to undertake a risk assessment to determine what the actual risks are and what control measures will be required to ensure the risk is at an acceptable level. AS 2865 contains information that may be used for this purpose.

It is considered that culverts with barrel lengths less than 20 m and with greater than 0.8 m clear size or 1.0m clear diameter are suitable for on site assessment of risk by the Inspector. Risk assessment for smaller culverts shall consider alternative access equipment, the use of cameras/scopes, the need for full inspection depending on the condition of external units and the use of the culvert (e.g. a stormwater drain would always require a risk assessment).

4.5 General Inspection Reporting Requirements

A systematic and organised approach is required when undertaking inspections. The process adopted should be efficient, effective, thorough and repeatable and cover all aspects of the culvert and potential safety issues. The report should be clear, concise, complete and accurate.

All defective components must be clearly identified with comments including the location and extent of the defect. Reference should be made to Sections 8, 9 and 10 for appropriate terminology to be adopted for the various culvert component defects and material defect types.

4.6 Component Identification

Numbering of culvert components utilises the following format:

- Culvert barrels are identified and numbered in order of increasing Straight Line Kilometre (SLK) values (refer to Section 5.2 for definition of SLK); and
- Units within each culvert barrel are identified and numbered from left to right facing the direction of increasing SLK.

Refer to the diagrams in Appendix A for terminology to be adopted for the various culvert components and terminology when reporting component defects and material defect types.

4.7 Photographic Records

Always take a photograph of the general view of the road from abutment 1 as well as the left-hand side view of the culvert.

It is vital that any culvert component showing signs of distress or visual defects is photographed. Issues identified in the detailed visual inspection report must be supplemented with a clear photograph and/or sketch of the specific concern.

If the defect is not immediately obvious within the photo, diagrammatic shapes (arrows, circles etc) highlighting the defect areas should be added where needed.

5.0 CULVERT INVENTORY DATA

Culvert information is stored in the Integrated Road Information System (IRIS) Network Manager. Various attributes are recorded and stored to identify each culvert on State Roads and National Highways. This inspection should be used as a check to verify and update data.

The culvert inventory data referenced in the detailed visual inspection form and recorded in IRIS is defined below in Sections 5.1 to 5.9.

5.1 Culvert Number

This is an optional field. Culverts can be numbered using an allocated Regional numbering system as outlined below. It is the Region's responsibility to manage their allocation of numbers from the allotted range for each culvert picked up in the field. If the culvert has been previously assigned a bridge number, then this number should be used as the culvert number. It is recommended that a culvert number be painted on every culvert on the left-hand side of the culvert end and also on the culvert marker post.

The culvert Regional numbering system utilises the following format:

- Great Southern – 10,000 to 19,999
- South West – 20,000 to 29,999
- Gascoyne – 30,000 to 34,999
- Goldfields-Esperance – 35,000 to 39,999
- Mid West – 40,000 to 49,999
- Pilbara – 50,000 to 59,999
- Kimberley – 60,000 to 69,999
- Metropolitan – 70,000 to 79,999
- Wheatbelt North – 80,000 to 89,999
- Wheatbelt South – 90,000 to 99,999

5.2 General Information

Certain general information heads the detailed visual inspection form. Most of this data does not change over time and can be entered from IRIS, drawings or previous inspections prior to the site visit. The following information is required:

- Road Name
- Road Number
- Crossing Name
- SLK: The Straight Line Kilometre (SLK) distance, defines the location of a point on a road to reference items on or adjacent to the road. SLK is a distance measure (to 2 decimal places) that maintains an historical reference of road points as road realignments introduce changes to the true distance measure. Culvert location is measured to the nearest 10 m from the centreline of the culvert. If the culvert is skewed relative to the road then the location is taken from the centreline of the culvert taken from the middle of the road
- Type of Carriageway: (Type of Cwy) A road is comprised of any combination of single (S), left (L) and right (R) carriageways. The direction of the road (increasing SLK) determines which carriageway of a divided carriageway is delineated as left or right carriageway

- Responsibility Area: The MRWA Region responsible for the management of the culvert
- Inspected By
- Inspection Date

5.3 Culvert Type

The general culvert type selected from the following list shall be recorded by the Inspector, to be stored in IRIS. If there is a mix of culvert types, this should be noted in the general comments section.

- Arch
- Bedlog
- Box
- Circular
- Masonry

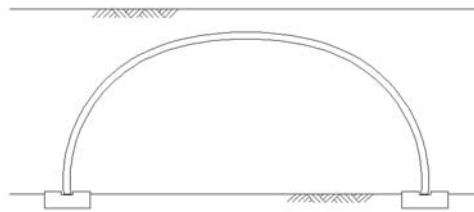

Figure 1 - ARCH TYPE CULVERT



Figure 2 - BEDLOG TYPE CULVERT

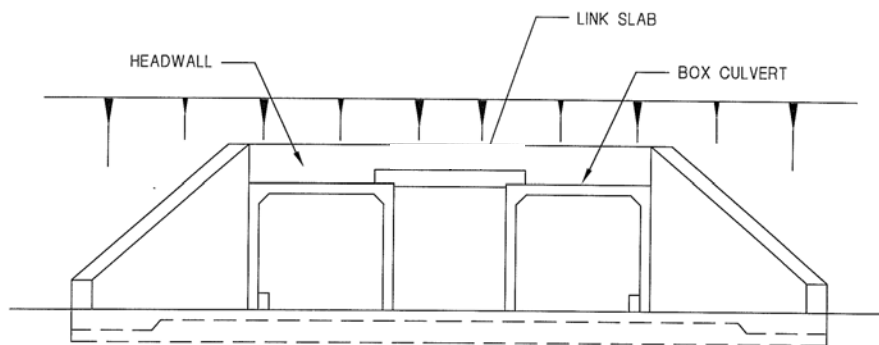

Figure 3 - BOX TYPE CULVERT

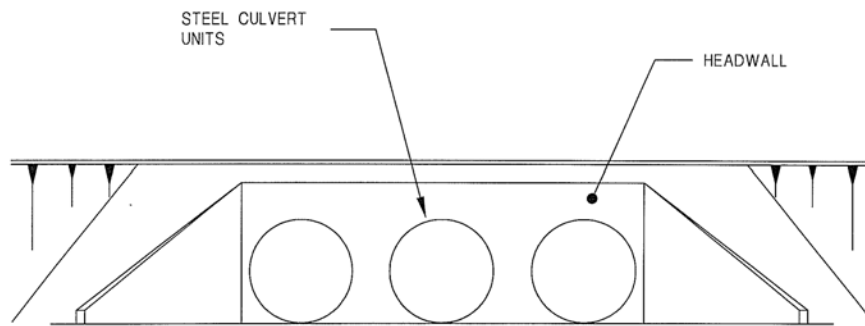

Figure 4 - CIRCULAR TYPE CULVERT



Figure 5 - MASONRY TYPE CULVERT

5.4 Culvert Material

The type of material from which the culvert's superstructure or spanning component is constructed is linked to the inspection frequency and material defects expected in culvert assets. If there is a mix of culvert materials, this should be noted in the general comments section with the predominant material listed. If the type of material is not one of the following, details shall be annotated in the inspection report. The following culvert materials are recorded in IRIS:

- Aluminium
- In Situ Reinforced Concrete
- Masonry
- Mass Concrete
- Plastic
- Precast Reinforced Concrete
- Steel
- Timber

5.5 Number of Barrels

The number of barrels crossing the road is recorded as per Figure 6 below. For example, the photographs on the cover of these guidelines show a nine barrel box culvert (link slab type) and a five barrel pipe culvert.

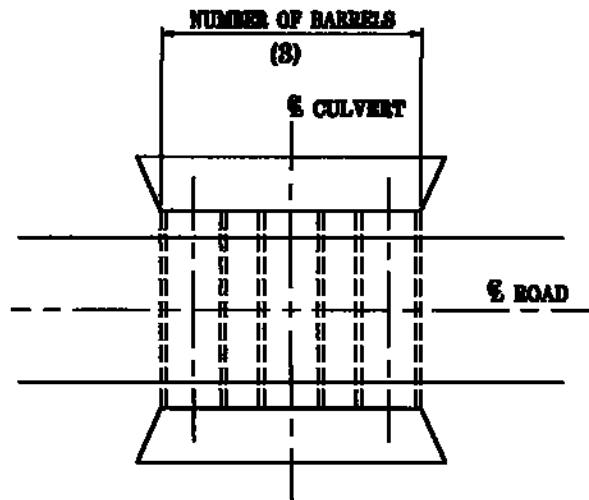

Figure 6 - NUMBER OF BARRELS

5.6 Barrel Length

This is the length of the barrel from one opening to the other opening across the width of the road. The length is measured to the nearest 0.2 m and recorded to one decimal place. Refer Figure 7.

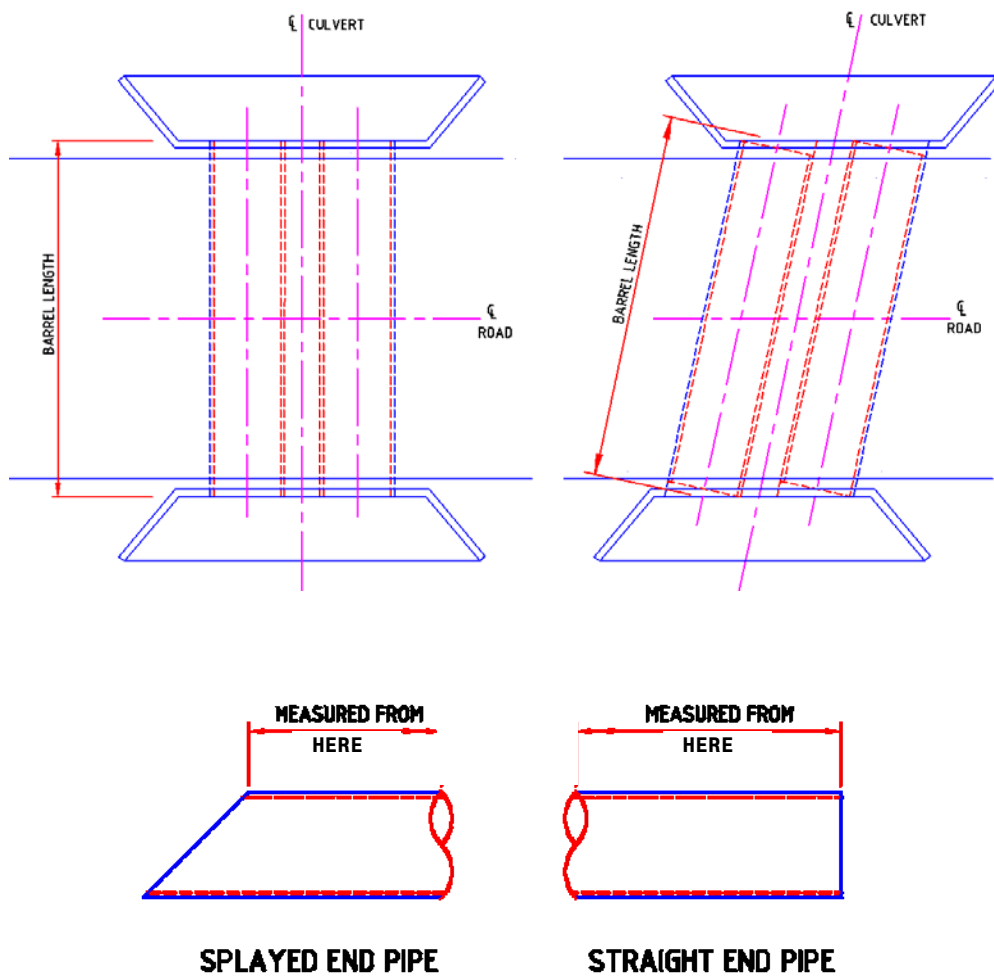

Figure 7 - BARREL LENGTH

5.7 Skew

The skew is defined as the angle between the longitudinal centreline of the culvert and a line perpendicular to the road centreline. It is measured in degrees to a tolerance of 5°. The skew can be positive or negative (refer Figure 8) and this should be noted on the inspection form.

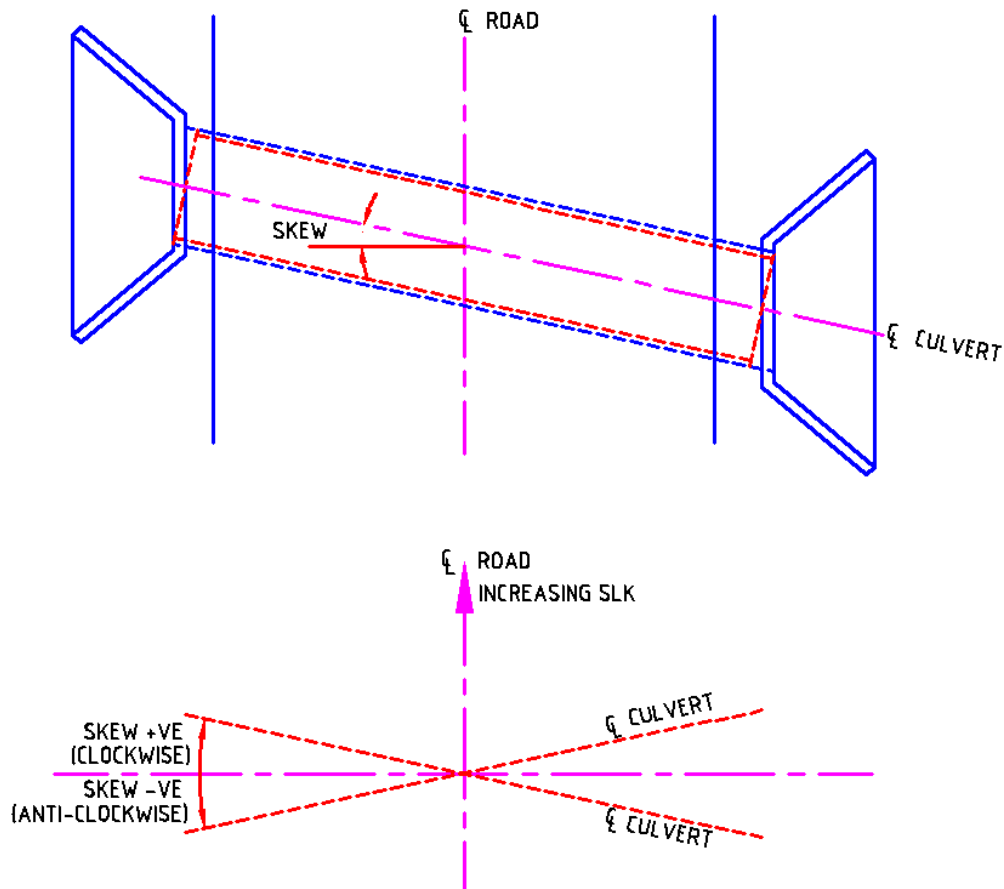

Figure 8 - CULVERT SKEW

5.8 Horizontal and Vertical Size

Rectangular shaped culverts are dimensioned by their horizontal and vertical size. The horizontal size is the internal width of a culvert, measured in metres to two decimal places. The vertical size is the vertical height from invert to obvert of the culvert, measured in metres to two decimal places. Refer Figure 9. Where there are rectangular culverts of different size, the largest size should be recorded and notes describing the other dimension(s) should be recorded in the general comments section.

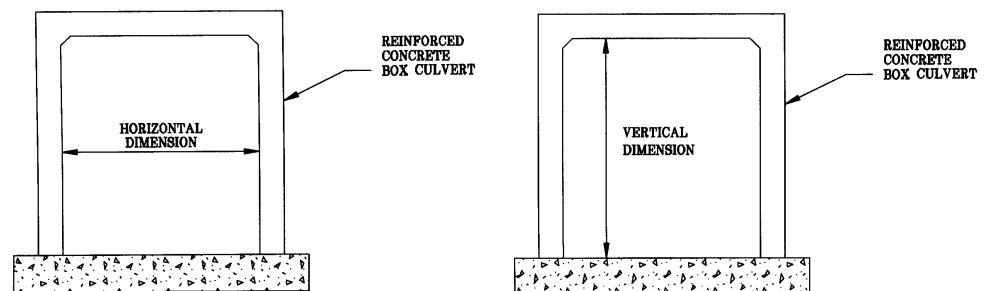

Figure 9 - RECTANGULAR CULVERT HORIZONTAL AND VERTICAL SIZE

5.9 Diameter

For circular culverts, diameter refers to the nominal internal diameter of a pipe, measured in metres to two decimal places. In the case of elliptical culverts, it is the mean diameter. Refer Figure 10. Where there are circular culverts of different diameter, the largest diameter should be recorded and notes describing the other diameter(s) should be recorded in the general comments section.

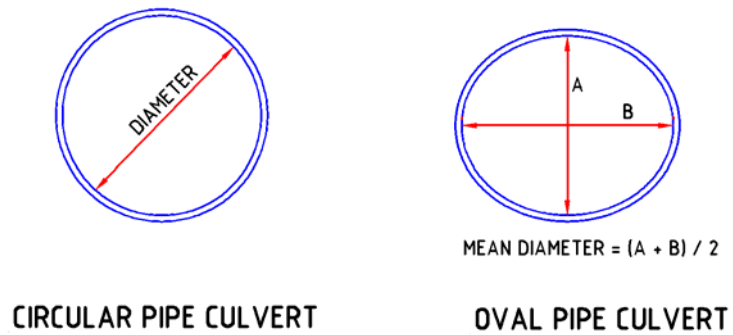

Figure 10 - CIRCULAR CULVERT DIAMETER

6.0 DETAILED VISUAL CULVERT INSPECTION FORM

The Detailed Visual Culvert Inspection Report is compiled on a standard form. Inspection items include the delineation, waterways, walls and aprons, and culvert units. The blank template is available on Main Roads Western Australia's (MRWA's) internet site www.mainroads.wa.gov.au selecting "Standards & Technical", then "Structures Engineering", "Asset Management" and refer to the "Culvert Detailed Visual Inspection Report - Level 2 Inspection Form" Word document. Examples of completed Culvert Detailed Visual Inspection Reports are given in Appendices B and C.

The Culvert Detailed Visual Inspection Report form has standardised headings. The headings are explained in the following sections with broad guidance on what to look for. The form is used to confirm or update culvert inventory information and record the current condition information. The form provides the input for planning and programming maintenance works for culverts.

The structural components of a culvert are:

1. Side walls of the culvert units or abutment walls or pier walls;
2. Top (or obvert) of the culvert units or link slabs or timber decking, the culvert's superstructure or spanning component;
3. Base of a culvert or invert;
4. Headwalls if they are in the adjacent area of the formation of a road and are thus load bearing; and
5. Wing walls if they are in the area of the formation of a road and are considered tall enough to cause stability issues if failure occurs.

6.1 General Information

Certain general information heads the Culvert Detailed Visual Inspection Report form. Most of this data does not change over time and can be entered from IRIS, drawings or previous inspections prior to the site visit but should be checked on site to confirm. The information has been described in Section 5.

6.2 Site Conditions

The best parking location is recorded for every culvert. The Inspector should review this information prior to the inspection and update details on site as required. Site conditions also include information on the access conditions to inspect the culvert and the safest point of access to the culvert openings as well as any identified potential hazards for the Inspector, including a qualitative judgement of the environment in which the culvert is located if deemed particularly aggressive.

6.3 Delineation

The condition of the delineators (e.g. width markers, guide posts) includes identifying any missing, damaged or obscured culvert delineator items. The condition of any barriers at a culvert location should also be recorded.

6.4 Waterways

The condition of the waterways includes noting any potentially damaging vegetation, debris, embankment erosion, scour, silt build-up, blocked openings, undermining and any damage to

guide-banks, revetment mattresses and rock protection. Uncontrolled and excessive growth of vegetation adjacent to the culvert does not in itself cause damage. It can however create fire hazard, blockage to the waterway and build-up of debris and moisture and for these reasons excessive vegetation should be reported. If the flow condition is compromised, comment should be made on whether vegetation growth is the main cause.

6.5 Walls & Aprons

Separate comments are required for headwalls (LHS, RHS), wing walls (LHS 1, LHS 2, RHS 1, RHS 2) and aprons where these items are present. Exception reporting is required for defects such as material defects, impact damage, cracking, spalling, honeycombing, corrosion, coating defects, undermining and settlement/movement.

A similar size crack in headwalls, wing walls and aprons compared to culvert units is not indicative of equivalent concerns for structural stability and strength. Most often headwalls and wing walls will not be structural components of a culvert because they are not load bearing. However, if headwalls and wing walls are in the area of the formation of a road (and not in the batter) they will then become structural components with associated tighter controls on defects. This distinction should be considered when recording defects in headwalls, wing walls, and aprons.

6.6 Culvert Units

Comments for defects are required for each barrel and joint making up the culvert. Each barrel will be made up of a series of connecting culvert units and all units within that barrel should be inspected, where possible, with any defects encountered documented including detail of what unit number the comment refers to. Exception reporting is required for defects such as material defects, impact damage, cracking, spalling, honeycombing, corrosion, coating defects, welds, fracture, buckling, warping, undermining and settlement/movement.

It is common that multi cell construction of precast box culverts uses link slabs. The link slabs span the gap equal to the culvert span between adjacent units. The link slabs may be either precast, or cast on top of the culvert base slab and simply lifted into position as required. These are treated as the obvert of a barrel of the culvert, rather than a separate structural component, and are recorded as such in the inspection form.

Although not common, timber culverts and masonry wall culverts comprise timber decking on abutment and pier walls. The decking spans the gap between walls. These components are all treated as part of the barrel of the culvert, rather than separate structural components, and are recorded as such in the inspection form.

6.7 Percentage Not Inspected

In some circumstances it may not be possible to closely inspect the entire culvert structure. This may be due to water flow, blockages from large debris or small culvert size for example. It is important that the Inspector accesses as much of the culvert as possible during the inspection. The use of cameras/scopes may need to be considered for some culverts, refer also Section 4.4. Where it is not possible to inspect the entire structure, the Inspector shall record the estimated percentage *not* inspected for each particular item.

If a critical item cannot be fully inspected and there are signs of potential underlying problems, reinspection or a special inspection and investigation shall be programmed for a more appropriate time.

6.8 Severity Level

A severity level is to be assigned to inspection item components for the condition of the waterway scour, waterway flow, headwalls, wing walls, aprons, each culvert barrel and base slab. The severity level is a broad scale of indication of the condition and can be related to the importance and timing of identified work.

Severity Level	Description
1	The item is in <i>excellent</i> (as-new) condition. No deficiencies.
2	The item is in <i>good</i> condition. No noteworthy deficiencies that affect the condition of the culvert. Insignificant damage and defects only with negligible misalignment. No work required.
3	The item is in <i>fair</i> condition but requires attention before the next inspection. All primary structural components are functional and fit for purpose but may have minor section loss, cracking, spalling or scour. Moderate deterioration or disintegration and minor settlement or misalignment.
4	The item is in <i>poor</i> condition and requires attention in the next financial year. Without repairs there is potential for failure leading to a critical situation. Advanced section loss, deterioration, significant spalling or scour have affected primary structural components. Considerable settlement or misalignment.
5	The item is in <i>critical, imminent failure</i> condition and requires immediate attention. Major deterioration or section loss present in primary structural components affecting structural stability.

Table 1 - SEVERITY LEVEL CONDITION RATING

Table 1 provides the broad definitions of severity levels. Further details and description of the different severity level ratings are provided in Section 10 and Appendix D.

6.9 Work Item Code(s)

Where the Inspector considers that maintenance or other further work is required, the standard work item description code(s) is to be written in this box. Table 2 gives work items applicable to culverts. This list is a subset of the complete IRIS Work Item Codes developed for MRWA's structural assets. A detailed work description needs to also be written on the report to enable cost estimation for future works programming.

General Supporting Activities

Work Item Code	Item Description
G003	Detailed Inspection (L2)
G006	Environmental Requirements
G008	Geotechnical Investigation
G010	Monitor Defect
G015	Waterways Design
G016	Review Structure after Next Detailed Inspection

Preventative Maintenance

Work Item Code	Item Description
P101	Seal Timber
P103	Fungicide Treatment

Routine Maintenance

Work Item Code	Item Description
R202	Remove Graffiti
R203	Repair Scour (Minor)
R204	Eradicate Termites
R205	Clear Vegetation
R207	Deck Surface - Maintain
R208	Drainage - Maintain
R210	Fence - Remove
R211	Fence - Repair (Control of Access)
R212	Guardrail - Maintain / Repair
R213	Kerb - Repair (Minor) - Non Structural
R215	Sign - Maintain

Specific Works

Work Item Code	Item Description
S301	Embankment - Repair
S308	Widen Embankment
S322	Control Fauna (Pest)
S324	Control Corrosion
S336	Replace with Culvert
S350	Repair Scour (Major)
S352	Strengthen
S357	Widen
S364	Footpath - Install
S378	Services - Relocate
S385	Services - Repair
S392	Walkway - Repair
S437	Decking - Repair (Timber)
S443	Drainage - Install
S449	Drainage - Repair
S461	Footpath - Repair
S467	Guardrail - Install
S471	Kerb - Extend
S473	Kerb - Repair
S507	Bedlog - Repair
S510	Bedlog - Shim
S537	Footpath Railing - Repair
S578	Wing Wall - Construct
S585	Wing Wall - Extend
S588	Wing Wall - Repair
S701	Apron - Repair
S716	Barrel - Repair
S731	Headwall - Repair

Table 2 - WORK ITEM CODES FOR CULVERTS

7.0 TYPICAL WA CULVERT MATERIAL TYPES

There are four basic materials used in Western Australia (WA) to construct different culvert types. The material used for construction has a direct link to the expected defects and the required frequency of inspection as outlined in Section 4.2.

7.1 Timber Culverts

Timber culverts are sometimes referred to as bedlog culverts, and there are a number of these culverts still in service. Being constructed of timber, they are susceptible to significant and relatively rapid deterioration, and require the most frequent inspection cycle of all culvert types.

Timber culverts must be differentiated from timber bridges. Any deck supported on timber stringers (longitudinal beams), regardless of clear opening size, is defined as a bridge and is inspected as such. Timber culverts are therefore only those without timber stringers with clear openings of less than or equal to three metres.



Photo 1 - TIMBER BEDLOG CULVERT

7.2 Concrete Culverts

Concrete culverts are the most common type of culvert and are typically precast pipes or boxes. Inspections need to cover the types of defects similar to those associated with concrete bridges, such as cracked, spalled or delaminated concrete and exposed or rusting reinforcement.

The concrete can either be precast or cast in situ and is widely used for bridging over small waterways and for pedestrian or stock underpasses.

The original concrete culverts were cast in situ boxes and many suffer from cracking and spalling due to lack of concrete cover or ingress of moisture. Once repairs are required to these structures (such as concrete patching or crack repairs) they tend to be an ongoing problem as other areas fail due to general dampness through the porous concrete. More recent precast concrete units generally appear more robust and perform well, although there are some reinforcement corrosion problems in salt affected areas of WA.



Photo 2 - REINFORCED CONCRETE BOX CULVERT (LINK SLAB TYPE)



Photo 3 - CONCRETE PIPE CULVERT

7.3 Steel Culverts

Steel culverts are pipe culverts. Most of the deterioration of the metal occurs at the pipe invert where the water ponds. Inspections are required to check protective coatings and galvanising, and for cracks, loss of section and corrosion, especially around joints and seams, and the condition of the invert. The pipe inverts can also be affected by abrasion if the sediment content of the water flow is high.

Pipes may be of multi-plate bolted constructed or by forming the pipe barrels with the use of helical continuous lock seam running parallel to corrugations.



Photo 4 - STEEL PIPE CULVERT

7.4 Masonry Culverts

Masonry wall culverts are constructed in situ with a road surface constructed of either timber decking or concrete link slabs. Although not a common construction material for WA culverts, masonry has been used. Defects in masonry are mostly related to the breakdown of its components (including the mortar joints) over time.

7.5 Other Culverts

Aluminium and plastic pipe culverts are uncommon but have been used for construction of some culverts in WA. Inspections are required to check for splits and material breakdown, especially around joints and seams, and the condition of the invert. The pipe inverts can also be affected by abrasion if the sediment content of the water flow is high.

8.0 COMMON MATERIAL DEFECTS

This section describes the typical defects that can be found in the various materials used to construct culverts in Western Australia. The key items as outlined below should provide enough guidance but if further details are needed these may be available in the *Condition Assessment - Level 2, Detailed Visual Bridge Inspection Guidelines for Concrete and Steel Bridges*, document 6706-02-2233 and in the *Condition Assessment - Level 2, Detailed Visual Bridge Inspection Guidelines for Timber Bridges*, document 6706-02-2231 as appropriate.

8.1 Timber

Timber is susceptible to significant deterioration but is a material that, combined with appropriate inspection and preventative maintenance, can be preserved for a very long life.

Rot/Decay – The fungi responsible for the rot of timber can only grow and attack the timber fibres in the presence of both moisture and oxygen. Where there is too little of one or the other, the rot cannot sustain itself. Thus for dry timber, where the internal moisture content is low, rot will generally not occur.

Insect Attack – Timber is required to be protected from termite attack. For timber components in saline river estuaries there is also danger from a variety of marine borers and again, timber protection is essential. Any activity of such insects shall be noted on the inspection form with the requirement for appropriate treatment.

Splits – Splits in timber result in the opening up within a component. This accelerates the weathering and deterioration of the timber material with significant loss of member strength.

Fire – Timber is susceptible to fire damage. The strength of a timber component following a fire depends on the portion of wood that has been charred. It is reasonable to assume the strength of charred sound timber is 80% of its original strength (before the fire).

8.2 Concrete

Concrete is used in culverts as mass concrete or normally it is combined with steel reinforcement. Defects in concrete are often related to the lack of durability resulting from the composition of the concrete, poor placement practices, poor quality control, insufficient curing or the aggressive environment in which it is placed.

Cracking – It is recognised that in reinforced concrete some cracks will form. As long as these cracks remain hairline they may be considered harmless structurally but may open up and progressively spread to longer and wider cracks becoming a durability issue. Cracks should be photographed to enable historical recording of crack propagation and growth.

Scaling – Scaling is the localised flaking or loss of surface concrete to a depth of approximately 5mm. Scaling is prone to occur in poorly finished or overworked concrete where too many fines and not enough entrained air is found near the surface. Scaling is generally rather superficial and does not extend to the reinforcement but may lead to a reduction in overall durability.

Spalling – A spall is a fragment which has been detached from a larger concrete mass. Spalling is a continuation of the corrosion process and represents a serious defect in the concrete, exposing the reinforcement.

Delamination – Delamination is a discontinuity in the surface concrete which is substantially separated but not completely detached from the adjoining concrete. Visibly it may appear as

a solid surface but can be identified by the hollow sound when tapping with a light hammer. Delamination begins with the corrosion of reinforcement and subsequent cracking of the concrete parallel to the exterior surface.

Dampness – Areas of the concrete surface that are wet or damp without any obvious cause may be an indication of moisture penetration through the concrete. If this is the case, then it may eventually lead to the corrosion of the steel. Such features should be noted and further investigation undertaken.

Surface Defects – Surface defects are not necessarily serious in themselves but are indicative of a potential weakness in the concrete. These include segregation, cold joints, honeycombing, deposits such as efflorescence, exudation, rust stains, erosion caused by the action of flowing fluids and general wear.

Patching or Other Repairs – The condition of the repair or patch will indicate whether the underlying problem has been solved or if it has been merely covered up and is actively continuing under the patch. Cracking, delamination, rust stains or spalling around the patch indicates further investigations and repairs are needed.

Alkali Aggregate Reaction – AAR or Alkali Silicate Reaction (ASR) is the phenomenon where some aggregates react adversely with the alkalis in cement to produce a highly expansive alkali-silica gel. Three factors must be present: reactive silica in the aggregate; significant alkalinity; and moisture. The expansion of the gel leads to cracking and deterioration of the concrete. AAR can be difficult to recognise and identify although giving visible external warnings of the internal damage. Typical adverse features of AAR in concrete structures include cracking expansion and consequent spalling of fragments of surface concrete and the presence of gel in fractures. AAR typically takes years to develop and is not often observed in culverts as they have shorter life expectancies.

Corrosion of Reinforcement – The concrete alkalinity protects the reinforcement from corrosion but when moisture, air and/or chloride ions above a certain concentration penetrate through the concrete to the reinforcement, this protection breaks down and corrosion commences. In the initial stages, corrosion may appear as rust stains on the concrete surface. In the advanced stages, the surface concrete cracks, delaminates and spalls off exposing heavily corroded reinforcement. Spalling and delamination are indications of advanced corrosion.

8.3 Steel

Steel as a structural material when not encased in concrete has defects related to poor quality control or the aggressive environment in which it is placed.

Corrosion – Corrosion, or rusting, will only occur if the steel is not protected or if the protective coating wears or breaks off. Corrosion on carbon steel is initially fine grained but as rusting progresses it becomes flaky and delaminates exposing a pitted surface. The process continues with progressive loss of section.

Permanent Deformations – Steel pipe culvert permanent deformations can take the form of bending, buckling, twisting or elongation, or any combination of these. Bending generally occurs in the direction of the applied loads whereas buckling occurs in a direction perpendicular to the applied load.

Cracking – Cracks represent a linear fracture in the steel and are generally caused by fatigue and can lead to brittle fracture. Brittle fracture usually occurs without prior warning or plastic deformation and represents complete material disintegration through the component. Cracks in steel should never be treated lightly and although not common for steel pipe culverts, all details must be recorded with recommendation for urgent further investigations.

8.4 Masonry

Masonry is made of stones or bricks bonded together by mortar. Defects in masonry are mostly related to the breakdown of its components over time. A similar size crack in masonry and concrete is not indicative of equivalent concerns for structural stability and strength, with masonry having greater ability to withstand larger cracks and without underlying reinforcement to protect. This distinction should be considered when recording defects in masonry.

Cracking – Cracks develop in masonry as a result of non-uniform settlement, thermal restraint and overloading. Cracks develop either at the interface between the mortar and stone, following a zigzag pattern or propagate through the joint and stone in a straight line.

Splitting, Spalling and Disintegration – These effects are caused by either the actions of weathering and abrasion or by the actions of acids, sulphates or chlorides.

Loss of Mortar and Stones – Loss of mortar is the result of destructive action of water wash, plant growth or softening by water containing dissolved sulphates or chlorides. Once the mortar has disintegrated it may lead to loss of stones.

8.5 Coating Systems

Coating defects are a serious concern for culverts. Loss of a protective coating for components that are often submerged can result in accelerated deterioration. Defects include loss of coating adhesion, incompatibility of successive coats, subsurface rusting, mechanical damage and inadequate coating on sharp edges and welds.

9.0 DEFECTS UNRELATED TO MATERIALS

A number of items need to be inspected which are not related to defects in construction materials used in the culvert but which, if not checked and rectified, could be a cause of future deterioration.

9.1 Damage Due to Accidents

The most common components affected by vehicle impact are delineators and less frequently wing walls, which can be severely abraded, spalled or damaged. Damage is usually self-evident.

9.2 Drainage

Inadequate collection of runoff water from the approaches can cause erosion, piping and washout or scour of the approach embankment and batter slopes, particularly in areas where flows are concentrated at the ends of barrel openings. These areas should be inspected, particularly after heavy rain or flooding.

9.3 Debris

The build-up of debris on the upstream side of a culvert over a flood prone waterway can cause high loads being imposed on the culvert. Build-up of debris can also cause: blockage of the waterway which can exacerbate problems of scour; undermining; flooding; and in extreme cases, total blockage and diversions of the watercourse.

The build-up of debris is dependent on upstream catchment conditions and is usually most severe in culverts with small openings or low freeboard.

9.4 Vegetation

Uncontrolled and excessive growth of vegetation under or adjacent to the culvert does not in itself generally cause damage. Some vegetation is beneficial to the stability of the embankments and surrounding soil and can help to prevent siltation of the culvert and scour. Vegetation can however create a fire hazard, blockage to the waterway and build-up of debris and moisture and for these reasons should be reported.

In general, a 2 to 3 m zone beyond the outer culvert components or within the road reserve (whichever occurs first) can be adopted as a recommended vegetation clear zone. Suitability of this rule-of-thumb to the specific site needs to be considered for particular vegetation, environment and culvert conditions.

9.5 Scour

Scour of foundations caused by excessive stream flows or changes in the alignment of the stream channel can result in progressive settlement or movement of culvert units, which if not rectified may ultimately cause total failure.

Where evidence of scour, degradation or aggradations of the stream bed exists, this shall be noted by the Inspector as a record of the existing condition which may then be compared with the relevant data from past and future inspections. Changes between inspections in

conditions of the stream bed on the upstream and downstream sides of the culvert shall also be noted.

Any scour under an outlet apron has potential to cause undermining along the entire barrel length. As such, there is can be no such thing as a safe distance of scour from the outlet apron. Details as outlined above shall be recorded for all scour and judgement made on its severity.

9.6 Movement/Settlement

Movement of the culvert units or wall supports may result from scour, movement of the ground itself, poorly compacted embankment, excessive earth pressure caused by movements or settlements of the approach fill, or erosion, piping, washout or scour of the approach.

10.0 SEVERITY LEVEL RATING



The assignment of severity level ratings is an important part of the inspection process as it gives a qualitative and quantitative measure of the culvert component's individual condition and an indication of the timeframe for required maintenance works. The severity level rating is on a scale of 1 to 5 as outlined in Section 6.7. The following descriptions and photographs can be used as a guide to the allocation of the appropriate severity level rating.



As outlined in Section 6, it is important to consider the load bearing significance and stability issues of the affected area of each component in the determination of the severity level rating and the timeframe for required maintenance works. For example, defects to culvert ends may not be as severe as a comparable defect underneath the trafficable lanes.

10.1 Waterways

10.1.1 Scour



Severity Level	Description	Photographs
1	No waterways issues identified with no scour.	 <p data-bbox="970 1205 1235 1234">No scouring present</p>



Severity Level	Description	Photographs
2	Minor scouring may be present at either the inlet channel, outlet channel, on the road embankment either side of the wing walls or on the road shoulder behind either headwall.	 <p data-bbox="853 694 1348 728">Minor scour on the road embankment</p>  <p data-bbox="874 1200 1327 1234">Minor scour under the outlet apron</p>

Severity Level	Description	Photographs
3	Noticeable scouring is present at either the inlet channel, outlet channel, on the road embankment either side of the wing walls or on the road shoulder behind either headwall. The level of scouring is not likely to develop into a potential hazard to stability or cause significant structural damage in the short-term.	 <p data-bbox="831 645 1369 678">Noticeable scouring under the inlet apron</p>  <p data-bbox="858 1169 1342 1202">Scouring of the downstream riverbed</p>
4	Significant scouring is present at either the inlet channel, outlet channel, on the road embankment either side of the wing walls or on the road shoulder behind either headwall. The level of scouring is likely to develop into a potential hazard to stability or cause significant structural damage to the culvert.	 <p data-bbox="847 1731 1353 1765">Severe scouring under the pipe culvert</p>



Severity Level	Description	Photographs
5	Advanced scouring is present that is currently causing stability issues or will very quickly cause significant structural damage to the culvert.	 <p data-bbox="759 600 1442 663">Water is no longer flowing through the culvert but is flowing underneath with structural failure of the base</p>



10.1.2 Flow



Severity Level	Description	Photographs
1	No waterways issues identified with no impediments to the flow condition of the culvert units.	 <p data-bbox="919 1301 1283 1328">No obstruction to water flow</p>
2	Minor silting or obstruction of the waterway up to 10% of entry/exit.	 <p data-bbox="858 1671 1340 1697">Minor (< 10%) silting of the waterway</p>

Severity Level	Description	Photographs
3	<p>Silting or obstruction of the waterway of between 10% and 25% of entry/exit. Silting is evident along the length of the culvert.</p>	 <p>Vegetation blocking the culvert entrance</p>
4	<p>Silting or obstruction of the waterway of over 25% of entry/exit.</p>	 <p>Culvert opening is blocked by vegetation</p>
5	<p>Silting or obstruction of the waterway at entry/exit is so severe that water flow is likely to cause structural damage to the culvert.</p>	 <p>Box culvert is almost completely blocked</p>



10.2 Walls & Aprons



Severity Level	Description	Photographs
1	All structural components are in good condition with little or no deterioration.	 <p data-bbox="762 768 1439 797">As-new condition of headwall, wing walls and apron</p>
2	Minor deterioration or damage only in structural components. Defects are more surface in nature and do not affect the structural integrity.	 <p data-bbox="751 1355 1450 1420">Cracks and minor damage to concrete wing wall (non primary structural component)</p>  <p data-bbox="774 1915 1428 1944">Construction joint on headwall and minor cracking</p>



Severity Level	Description	Photographs
3	Medium deterioration or damage in structural components. Defects are not yet affecting the structural integrity.	 <p data-bbox="938 703 1267 741">Cracking in masonry wall</p>  <p data-bbox="967 1339 1238 1377">Badly cracked apron</p>  <p data-bbox="746 1760 1455 1830">Wing wall is cracked and is tilting over (caused by tree growth)</p>



Severity Level	Description	Photographs
4	Significant deterioration or damage in structural components. Defects are starting to affect the structural integrity.	 <p data-bbox="756 645 1447 678">Headwall has separated from pipes and is collapsing</p>  <p data-bbox="778 1196 1425 1263">Headwall has concrete sections missing, pipes in danger of being undermined</p>
5	Structural components are showing signs of distress or have already failed. Defects affect the structural integrity.	 <p data-bbox="1015 1648 1185 1682">Apron failure</p>



10.3 Culvert Units



Severity Level	Description	Photographs
1	<p>All structural components are in good condition with little or no deterioration.</p> <p>Barrels – the line and invert of the culvert is straight with no water being retained in the culvert.</p> <p>Concrete – any cracking is only hairline (≤ 0.1 mm) and cracks are widely spaced and very infrequent; no spalling; minor efflorescence on the underside of the link slab or near unit joints.</p> <p>Steel – no evidence of corrosion.</p> <p>Masonry – any cracking is only hairline or fine (≤ 0.3 mm) and contained within the mortar joints.</p> <p>Timber – may have very minor splits only.</p>	 <p>No timber deterioration</p>  <p>No concrete spalling or cracking (Note: Silting is severity level 3)</p>



Severity Level	Description	Photographs
2	<p>Minor deterioration or damage only in structural components. Defects are more surface in nature and do not affect the structural integrity or ability to withstand significant water flows. Culvert barrel cell joints seem tight with no evidence of leaching.</p> <p>Barrels – the line and invert of the culvert is straight but there is minor differential settlement (≤ 5 mm) which may have resulted in some water ponding in the culvert.</p> <p>Concrete – any cracking is fine (> 0.1 mm and ≤ 0.3 mm) and cracks are widely spaced and very infrequent; minor localised spalling; localised rust staining; no exposed reinforcing steel; damp patches and efflorescence may be visible.</p> <p>Steel – localised superficial surface corrosion and no pitting.</p> <p>Masonry – medium cracking (> 0.3 mm and ≤ 1.0 mm) of the mortar between blocks or minor loss of the mortar between blocks; mortar is still sound.</p> <p>Timber – minor rot zones; may have splitting or weathering.</p>	 <p>Localised rust staining</p>  <p>Minor cracking</p>  <p>Minor rust staining around the joints</p>



Severity Level	Description	Photographs
		 <p data-bbox="780 725 1422 757">Minor rust staining and areas of spalled concrete</p>  <p data-bbox="766 1303 1439 1335">Exposed reinforcement in outside leg of box culvert</p>
<p data-bbox="277 1352 293 1384">3</p>	<p data-bbox="373 1352 703 1720">Medium deterioration or damage in structural components. Defects are not yet affecting the structural integrity or ability to withstand significant water flows. Some evidence of fill or water leakage passing through the culvert barrel cell joints.</p> <p data-bbox="373 1738 703 2033">Barrels – there may be some deviation of the line of the culvert due to local buckling, separation or differential settlement (> 5 mm and ≤ 30 mm) which may have resulted in water ponding in the culvert.</p> <p data-bbox="373 2051 660 2083">Concrete – infrequent</p>	 <p data-bbox="823 1944 1378 1975">Some limited rotting of timber components</p>

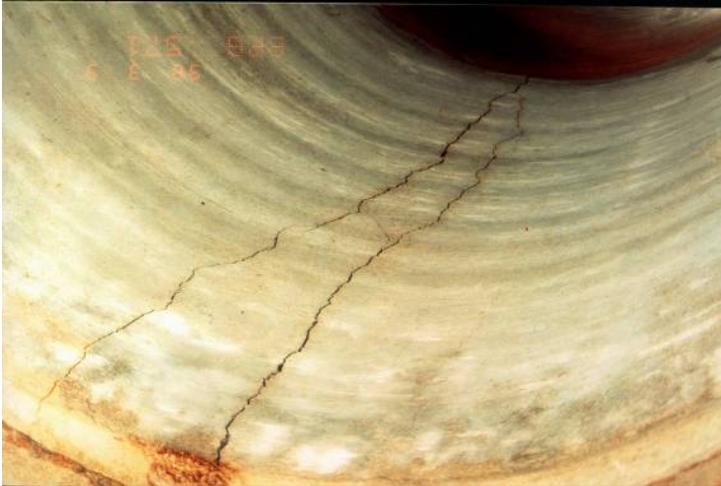

Severity Level	Description	Photographs
	<p>medium cracking (> 0.3 mm and ≤ 0.7 mm); fretting and spalling may be present; extensive rust staining; patches of dampness and efflorescence of 0.25 m² to 1 m² may be visible in any one unit.</p> <p>Steel – steel corrosion can be widespread but no flaking is evident; surface pitting may be evident especially at normal water level.</p> <p>Masonry – heavy cracking (> 1.0 mm and ≤ 2.0 mm) of the mortar or loss of mortar between blocks; mortar may be starting to lose strength and crumble.</p> <p>Timber – rot is more advanced; splits are evident.</p>	 <p>Evidence of leakage through the barrel joints</p>  <p>Spall in wall of culvert unit</p>  <p>Major rust staining and cracking of the pipe invert</p>

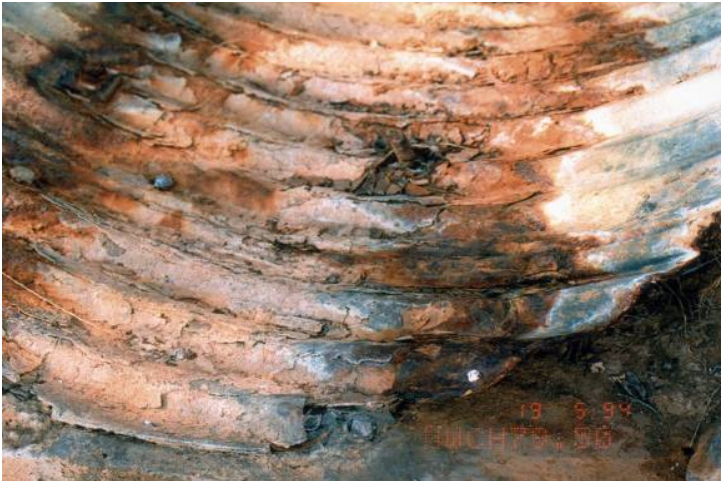

Severity Level	Description	Photographs
4	<p>Significant deterioration or damage in structural components. Defects are starting to affect the structural integrity or ability to withstand significant water flows. There is a likelihood that a major water flow will result in loss of pavement and/or culvert. Evidence of fill or water leakage passing through the culvert cell joints.</p> <p>Barrels – there may be a large deviation of the line of the culvert (> 30 mm) which may have resulted in an excessive amount of water being retained in the culvert.</p> <p>Concrete – heavy cracking (> 0.7 mm); fretting and spalling along large delaminated areas; exposed reinforcement exhibits signs of severe corrosion over large areas resulting in substantial loss of section; patches of dampness and efflorescence may be > 1 m² in any one unit.</p> <p>Steel – extensive steel corrosion; surface pitting and extensive flaking is evident resulting in localised areas of complete loss of steel section; noticeable loss of section over ≥ 10% of circumference.</p> <p>Masonry – very heavy cracking (> 2.0 mm) of the mortar or loss of mortar between blocks; blocks may have started slipping; mortar has become powdery.</p> <p>Timber – little solid</p>	 <p>Exposed reinforcement and spalled concrete</p>  <p>Badly damaged culvert (ends are typical of internal sections)</p>  <p>Exposed and corroded reinforcement</p>

Severity Level	Description	Photographs
	<p>timber remaining; timber has become fully friable; splits may be severe.</p>	 <p>Exposed reinforcement in the link slab</p>  <p>Major heavy longitudinal crack in the pipe invert</p>  <p>Heavy longitudinal crack in the top of the pipe</p>

Severity Level	Description	Photographs
		 <p data-bbox="820 730 1382 766">Heavy longitudinal cracks through the pipe</p>  <p data-bbox="788 1308 1414 1344">The end of the wall has major abrasion damage</p>  <p data-bbox="778 1939 1423 1975">Culvert pier wall is severely cracked and abraded</p>

Severity Level	Description	Photographs
5	Structural components are showing signs of distress or have already failed. Defects affect the structural integrity or ability to withstand water flows. Water flow is likely to result in loss of pavement and/or culvert. The road surface is uneven.	 <p data-bbox="788 725 1417 792">Severe corrosion damage of the pipe invert with complete loss of section in most locations</p>  <p data-bbox="892 1314 1310 1348">Localised signs of timber failure</p>  <p data-bbox="805 1953 1398 1986">Failed timber components, typical throughout</p>

Severity Level	Description	Photographs
		 <p data-bbox="794 680 1409 712">Spalled concrete and widespread delamination</p>  <p data-bbox="745 1301 1458 1332">Joints badly cracked with propping to reinstate stability</p>  <p data-bbox="745 1930 1458 1995">Misalignment of pipe culverts (repair needed to prevent scour and subsidence)</p>

Severity Level	Description	Photographs
		 <p data-bbox="740 725 1463 763">Major spalling of wall due to salt attack of reinforcement</p>  <p data-bbox="740 1303 1463 1370">Walls have major abrasion and have been propped to maintain structural stability</p>

APPENDIX A

CULVERT COMPONENTS AND TERMINOLOGY

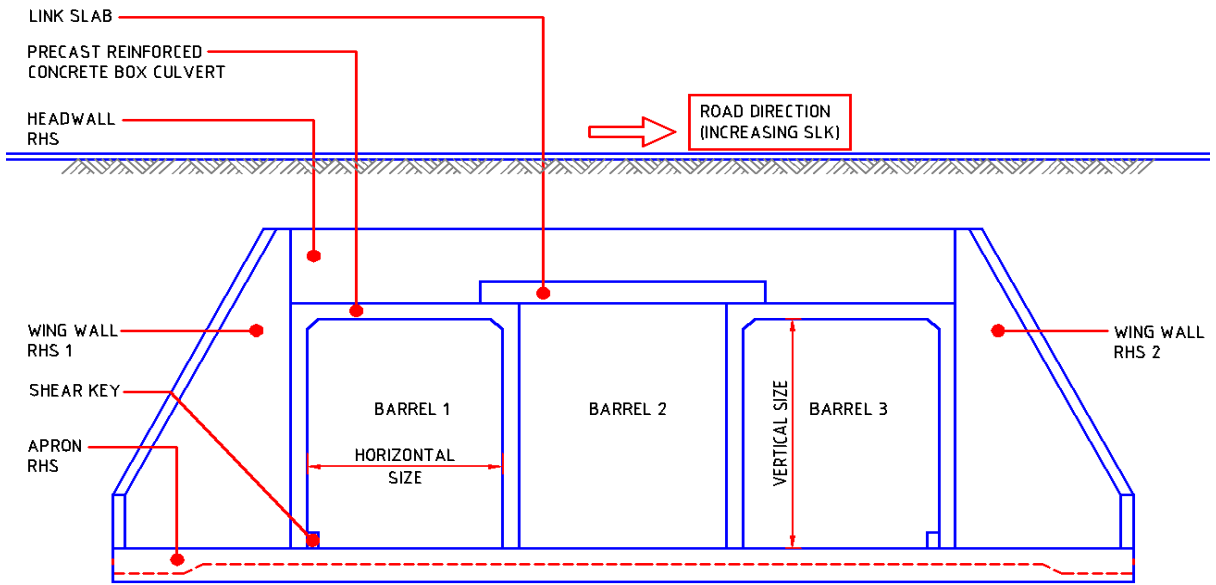

Sketch 1 - BOX CULVERT ELEVATION

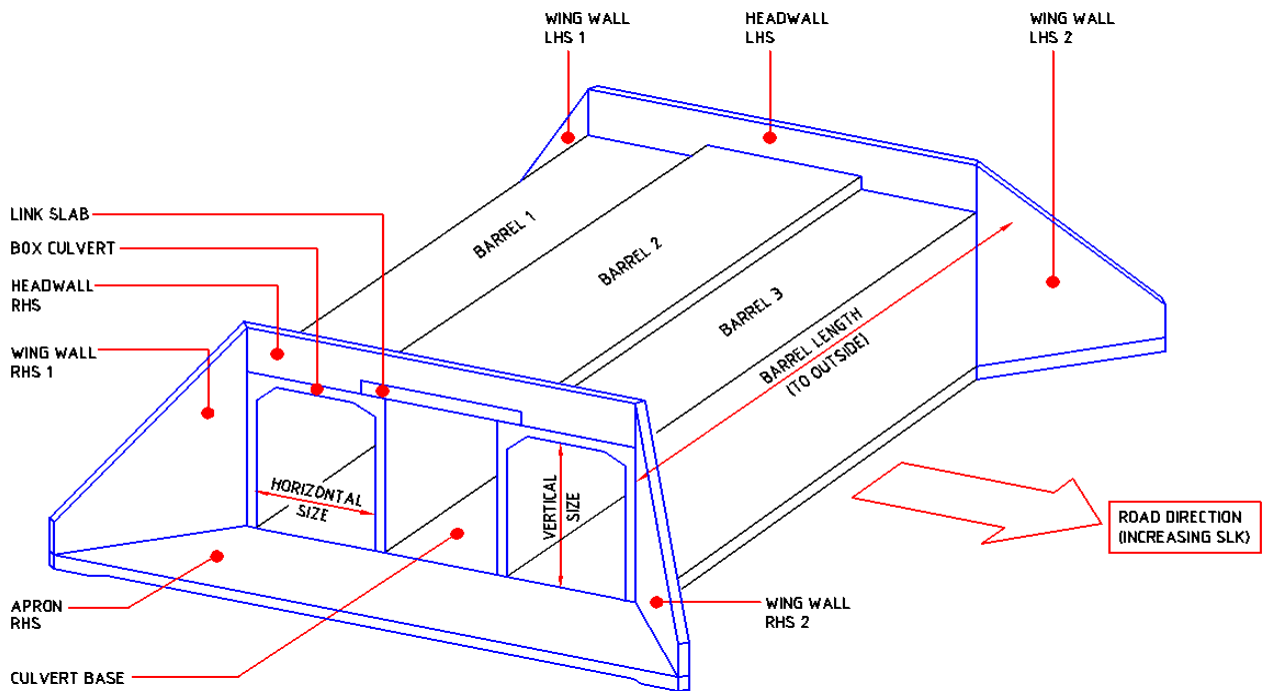

Sketch 2 - 3D BOX CULVERT

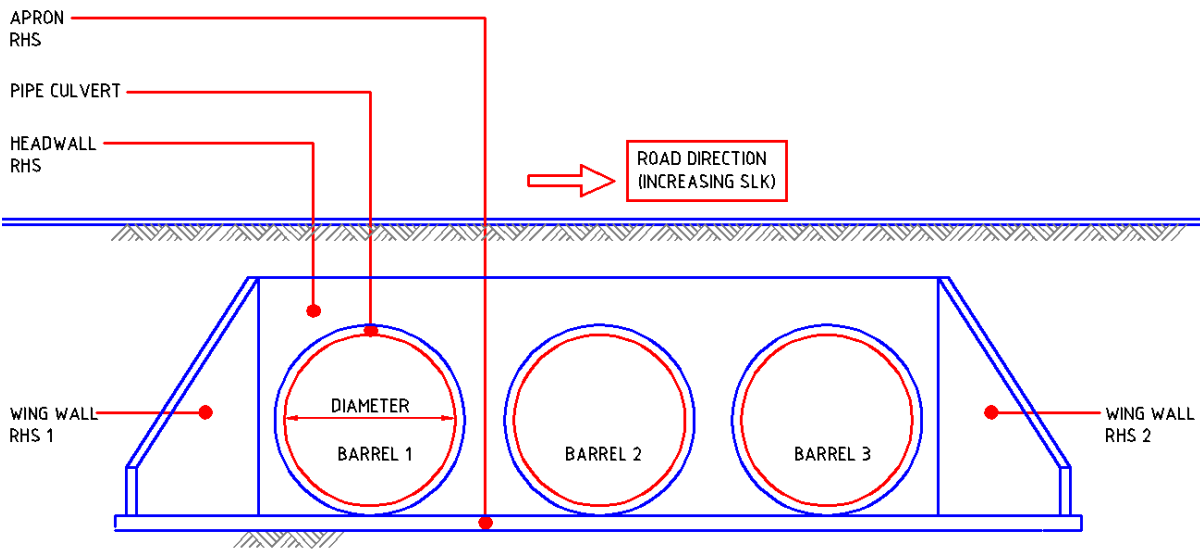

Sketch 3 - PIPE CULVERT ELEVATION

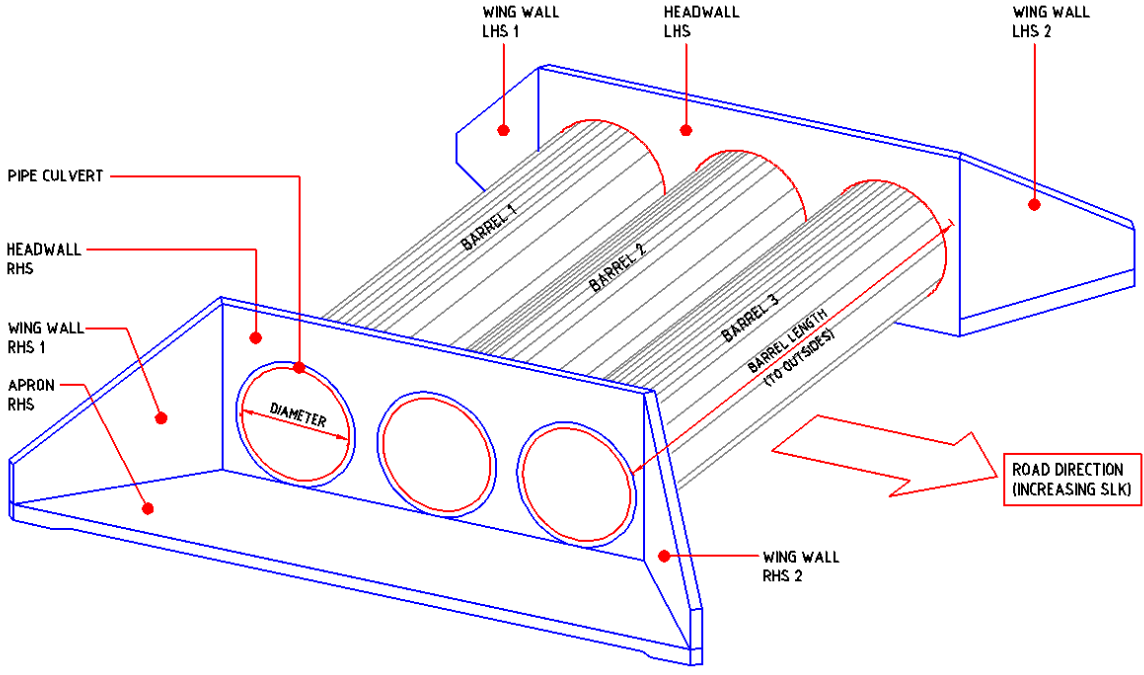

Sketch 4 - 3D PIPE CULVERT

APPENDIX B

CULVERT DETAILED VISUAL INSPECTION REPORT
(Level 2 Inspection)

EXAMPLE – RC BOX CULVERT



CULVERT DETAILED VISUAL INSPECTION REPORT (Level 2 Inspection)



Culvert Number:	Crossing Name: Unknown
Road Name: South Western Hwy	Road Number: H009
SLK: 21.91	Type of Cwy: S
Responsibility Area: Metropolitan	
Culvert Type: Box	Culvert Material: Precast RC
No. of Barrels: 2	Barrel Length (m): 16.4
Horizontal Size (m): 1.24	Vertical Size (m): 1.23
Diameter (m): N/A	Skew (°): 25
Inspected By: E. Smith	Inspection Date: 25-08-2009

Site Conditions		
Parking Position: Abutment 1, LHS, about 5 m from the culvert.	Environment:	
Access Conditions: Low embankments but gravel a little slippery.	Non-Aggressive	<input checked="" type="checkbox"/>
Potential Hazards: Debris at inlet, LHS.	Aggressive	<input type="checkbox"/>

Have issues been found that require further investigation? (Y/N) Y

Inspection Item	Not Inspected (%)	Severity Level	Comments <i>(Including location and extent)</i>	Work Item Code(s)
1. Delineation Delineators: missing, damaged, obscured			White posts with delineators in good condition.	
2. Waterways Vegetation, debris, embankment erosion, scour, silt build-up, blockages, damaged guide-banks, revetment mattresses, rock protection		Scour <input type="text" value="1"/> Flow <input type="text" value="3"/>	Heavy build-up of debris at inlet (LHS) requires clearing. Vegetation impeding waterway both sides, restricting flow.	R208 R205
3. Walls & Aprons Headwalls, wing walls, aprons: material defects, impact damage, coatings, movement/settlement		Head LHS <input type="text" value="2"/> Head RHS <input type="text" value="2"/> Wing LHS 1 <input type="text" value="2"/> Wing LHS 2 <input type="text" value="2"/> Wing RHS 1 <input type="text" value="2"/> Wing RHS 2 <input type="text" value="2"/> Apron LHS <input type="text" value="N/A"/> Apron RHS <input type="text" value="N/A"/>	4 mm crack between RHS wing wall 1 and RHS headwall. Not load bearing. Structural stability not affected. 0.7 mm crack between RHS wing wall 2 and RHS headwall. Not load bearing. Structural stability not affected.	
4. Culvert Units Culvert units, culvert base, joints: material defects, impact damage, coatings, movement/settlement <i>{Link slabs span the gap between adjacent units. These are treated as the obvert of a barrel of the culvert rather than a separate structural component.}</i> <i>{Any walls are treated as the sides of a barrel of the culvert rather than a separate structural component.}</i>		Barrel 1 <input type="text" value="4"/> Barrel 2 <input type="text" value="4"/> Barrel 3 <input type="text" value="N/A"/> Barrel 4 <input type="text" value="N/A"/> Barrel 5 <input type="text" value="N/A"/> Barrel 6 <input type="text" value="N/A"/> Base Slab <input type="text" value="2"/>	Barrel 1 – All units have delamination, spalling and corrosion of exposed reinforcement with section loss. Top of the barrel is in good condition throughout. Base is in good condition except minor spall in unit 10. Barrel 2 – All units have delamination, spalling and corrosion of exposed reinforcement with section loss. Top of the barrel is in good condition throughout except minor construction damage in unit 2. Base is in good condition throughout.	S336



CULVERT DETAILED VISUAL INSPECTION REPORT (Level 2 Inspection)



Severity Level Rating Descriptions

Severity Level	Description
1	The item is in <i>excellent</i> condition. No deficiencies.
2	The item is in <i>good</i> condition. No noteworthy deficiencies that affect the condition of the culvert. Insignificant damage and defects only with negligible misalignment. No work required.
3	The item is in <i>fair</i> condition but requires attention before the next inspection. All primary structural components are functional and fit for purpose but may have minor section loss, cracking, spalling or scour. Moderate deterioration or disintegration and minor settlement or misalignment.
4	The item is in <i>poor</i> condition and requires attention in the next financial year. Without repairs there is potential for failure leading to a critical situation. Advanced section loss, deterioration, significant spalling or scour have affected primary structural components. Considerable settlement or misalignment.
5	The item is in <i>critical, imminent failure</i> condition and requires immediate attention. Major deterioration or section loss present in primary structural components affecting structural stability.

General Comments

Culvert is in poor condition with attention required within the next couple of years to ensure structural integrity. Delamination and spalling has resulted in advanced corrosion of steel reinforcement over large areas of each culvert unit with advanced section loss. Culvert replacement is recommended.

This culvert has been inspected in accordance with the requirements of the Main Roads Western Australia Detailed Visual Culvert Inspection Guidelines for Level 2 Inspections.

Signature: *ERSmith*

Position: Asset Manager Bridges

Date: 25-08-2009



CULVERT INSPECTION REPORT PHOTO SHEET



Culvert No.:		Location: Metropolitan	Date: 25-08-2009
Road Name: South Western Hwy	Road No.: H009	SLK: 21.91	
Crossing: Unknown	Inspector: E. Smith		



Photo 1 - TOP VIEW FROM ABUTMENT 1 END



Photo 2 - LEFT HAND SIDE VIEW

Culvert No.:		Location: Metropolitan	Date: 25-08-2009
Road Name: South Western Hwy	Road No.: H009	SLK: 21.91	
Crossing: Unknown	Inspector: E. Smith		



Photo 3 - BUILD-UP OF DEBRIS AT INLET (LHS)



Photo 4 - VEGETATION RESTRICTING FLOW ON RHS



CULVERT INSPECTION REPORT PHOTO SHEET



Culvert No.:		Location: Metropolitan	Date: 25-08-2009
Road Name: South Western Hwy	Road No.: H009	SLK: 21.91	
Crossing: Unknown	Inspector: E. Smith		



Photo 5 - CRACK BETWEEN RHS WING WALL 1 AND RHS HEADWALL



Photo 6 - TYPICAL DELAMINATION AND SPALLING OF CULVERT UNITS



CULVERT INSPECTION REPORT PHOTO SHEET



Culvert No.:		Location: Metropolitan	Date: 25-08-2009
Road Name: South Western Hwy	Road No.: H009	SLK: 21.91	
Crossing: Unknown	Inspector: E. Smith		



Photo 7 - TYPICAL CORROSION OF REINFORCEMENT IN CULVERT UNITS



Photo 8 - 4 mm CRACK BARREL 2, UNIT 2, A2 SIDE

APPENDIX C

CULVERT DETAILED VISUAL INSPECTION REPORT (Level 2 Inspection)

EXAMPLE – STEEL PIPE CULVERT



CULVERT DETAILED VISUAL INSPECTION REPORT (Level 2 Inspection)



Culvert Number:	Crossing Name: Unknown
Road Name: Great Eastern Hwy	Road Number: H005
SLK: 78.58	Type of Cwy: S
Responsibility Area: Wheatbelt North	
Culvert Type: Circular	Culvert Material: Steel
No. of Barrels: 3	Barrel Length (m): 50.0
Horizontal Size (m): N/A	Vertical Size (m): N/A
Diameter (m): 1.81	Skew (°): 28
Inspected By: E. Smith	Inspection Date: 28-08-2009

Site Conditions		
Parking Position: Abutment 1, RHS, about 3 m from the culvert.	Environment:	
Access Conditions: Very high grassy embankments. Easy access.	Non-Aggressive	<input checked="" type="checkbox"/>
Potential Hazards: Debris at inlet, LHS. Fences on RHS, barrels 1 and 2.	Aggressive	<input type="checkbox"/>

Have issues been found that require further investigation? (Y/N) N

Inspection Item	Not Inspected (%)	Severity Level	Comments <i>(Including location and extent)</i>	Work Item Code(s)
1. Delineation Delineators: missing, damaged, obscured			W-beam guardrail in good condition LHS. White posts with delineators in good condition RHS.	
2. Waterways Vegetation, debris, embankment erosion, scour, silt build-up, blockages, damaged guide-banks, revetment mattresses, rock protection		Scour <input type="text" value="2"/> Flow <input type="text" value="2"/>	LHS blocked by tree fallen from A1 across Barrel 2. Small trees upstream of inlet. RHS apron undermined but stable.	
3. Walls & Aprons Headwalls, wing walls, aprons: material defects, impact damage, coatings, movement/settlement		Head LHS <input type="text" value="N/A"/> Head RHS <input type="text" value="N/A"/> Wing LHS 1 <input type="text" value="N/A"/> Wing LHS 2 <input type="text" value="N/A"/> Wing RHS 1 <input type="text" value="N/A"/> Wing RHS 2 <input type="text" value="N/A"/> Apron LHS <input type="text" value="N/A"/> Apron RHS <input type="text" value="2"/>	Apron on RHS in good condition but undermined as above.	
4. Culvert Units Culvert units, culvert base, joints: material defects, impact damage, coatings, movement/settlement <i>{Link slabs span the gap between adjacent units. These are treated as the obvert of a barrel of the culvert rather than a separate structural component.}</i> <i>{Any walls are treated as the sides of a barrel of the culvert rather than a separate structural component.}</i>		Barrel 1 <input type="text" value="2"/> Barrel 2 <input type="text" value="2"/> Barrel 3 <input type="text" value="2"/> Barrel 4 <input type="text" value="N/A"/> Barrel 5 <input type="text" value="N/A"/> Barrel 6 <input type="text" value="N/A"/> Base Slab <input type="text" value="2"/>	All barrels in good condition throughout with no out-of-round from large fill height. Concrete invert in all barrels in good condition throughout. Concrete patches at unit joints in fair condition throughout.	



CULVERT DETAILED VISUAL INSPECTION REPORT (Level 2 Inspection)



Severity Level Rating Descriptions

Severity Level	Description
1	The item is in <i>excellent</i> condition. No deficiencies.
2	The item is in <i>good</i> condition. No noteworthy deficiencies that affect the condition of the culvert. Insignificant damage and defects only with negligible misalignment. No work requirement.
3	The item is in <i>fair</i> condition but requires attention before the next inspection. All primary structural components are functional and fit for purpose but may have minor section loss, cracking, spalling or scour. Moderate deterioration or disintegration and minor settlement or misalignment.
4	The item is in <i>poor</i> condition and requires attention in the next financial year. Without repairs there is potential for failure leading to a critical situation. Advanced section loss, deterioration, significant spalling or scour have affected primary structural components. Considerable settlement or misalignment.
5	The item is in <i>critical, imminent failure</i> condition and requires immediate attention. Major deterioration or section loss present in primary structural components affecting structural stability.

General Comments

Culvert is good condition throughout with previous repairs effective.

This culvert has been inspected in accordance with the requirements of the Main Roads Western Australia Detailed Visual Culvert Inspection Guidelines for Level 2 Inspections.

Signature: *ERSmith*

Position: Asset Manager Bridges

Date: 28-08-2009



CULVERT INSPECTION REPORT PHOTO SHEET



Culvert No.:		Location:	Wheatbelt North	Date:	28-08-2009
Road Name:	Great Eastern Hwy	Road No.:	H005	SLK:	78.58
Crossing:	Unknown	Inspector:	E. Smith		



Photo 1 - TOP VIEW FROM ABUTMENT 1 END



Photo 2 - LEFT HAND SIDE VIEW

Culvert No.:		Location:	Wheatbelt North	Date:	28-08-2009
Road Name:	Great Eastern Hwy	Road No.:	H005	SLK:	78.58
Crossing:	Unknown	Inspector:	E. Smith		



Photo 3 - WATERWAY PARTIALLY BLOCKED BY TREE AT INLET (LHS)



Photo 4 - UNDERMINING OF APRON ON RHS

Culvert No.:		Location:	Wheatbelt North	Date:	28-08-2009
Road Name:	Great Eastern Hwy	Road No.:	H005	SLK:	78.58
Crossing:	Unknown	Inspector:	E. Smith		



Photo 5 - TYPICAL CONCRETE PATCH AT CULVERT JOINTS



Photo 6 - TYPICAL CULVERT BARREL AND CONCRETE INVERT

APPENDIX D

SEVERITY LEVEL RATINGS

SEVERITY LEVEL RATINGS

This table is to be used as a reference for determination of the appropriate Severity Level Rating for culverts when undertaking a Detailed Visual Culvert Inspection (Level 2).

Severity Level Ratings					
Component	1	2	3	4	5
Waterways - Scour	No waterways issues. No scour.	Minor scouring may be present at either the inlet channel, outlet channel, on the road embankment either side of the wing walls or on the road shoulder behind either headwall.	Noticeable scouring is present at either the inlet channel, outlet channel, on the road embankment either side of the wing walls or on the road shoulder behind either headwall. The level of scouring is not likely to develop into a potential hazard to stability or cause significant structural damage.	Significant scouring is present at either the inlet channel, outlet channel, on the road embankment either side of the wing walls or on the road shoulder behind either headwall. The level of scouring is likely to develop into a potential hazard to stability or cause significant structural damage to the culvert.	Advanced scouring is present that is currently causing stability issues or will very quickly cause significant structural damage to the culvert.
Waterways - Flow	No impediments to the flow condition of the culvert units.	Minor silting or obstruction of the waterway up to 10% of entry/exit.	Silting or obstruction of the waterway of between 10% and 25% of entry/exit. Silting is evident along the length of the culvert.	Silting or obstruction of the waterway of over 25% of entry/exit.	Silting or obstruction of the waterway at entry/exit is so severe that water flow is likely to cause structural damage to the culvert.

Severity Level Ratings

Component	1	2	3	4	5
<p>Walls & Aprons</p> <p><i>Applicable to:</i></p> <ul style="list-style-type: none"> • Headwalls • Wing walls • Aprons <p><i>Materials:</i></p> <ul style="list-style-type: none"> • Cast in situ concrete • Precast concrete • Timber • Masonry 	<p>General: In good condition with little or no deterioration. No movement of the headwall or the wing wall.</p> <p>And:</p> <p>Concrete: Hairline cracking (≤ 0.1 mm) and cracks are widely spaced and very infrequent. No spalling.</p> <p>Timber: May have very minor splits only.</p> <p>Masonry: Hairline cracking (≤ 0.3 mm) and contained within the mortar joints.</p>	<p>General: The headwall or wing wall may exhibit minor movement up to 10 mm but does not affect the structural integrity.</p> <p>And:</p> <p>Concrete: Fine cracking (> 0.1 & ≤ 0.3 mm) and cracks are widely spaced and very infrequent. Minor localised spalling and rust staining may be present. No reinforcement is exposed.</p> <p>Timber: Minor rot zones. May have splitting or weathering.</p> <p>Masonry: Medium cracking (> 0.3 & ≤ 1.0 mm) of the mortar between blocks. Mortar is still sound.</p>	<p>General: The headwall or wing wall may exhibit moderate movement (up to 20 mm) but does not affect the structural integrity.</p> <p>And:</p> <p>Concrete: Medium cracking (> 0.3 & ≤ 0.7 mm) infrequent. Fretting and/or spalling may be present. Extensive rust staining.</p> <p>Timber: Rot is more advanced. Splits are evident.</p> <p>Masonry: Heavy cracking (> 1.0 & ≤ 2.0 mm) of the mortar or loss of mortar between blocks. Mortar may be starting to lose strength and crumble.</p>	<p>General: The headwall or wing wall may exhibit large movement (> 20 mm) or the wing wall may be leaning due to earth pressure with possible loss of fill material behind it.</p> <p>And:</p> <p>Concrete: Heavy cracking (> 0.7 mm) with fretting and/or spalling along large delaminated areas. Any exposed reinforcement exhibits signs of severe corrosion over large areas resulting in substantial loss of section.</p> <p>Timber: Little solid timber remaining or timber has become fully friable. Splits may be severe.</p> <p>Masonry: Very heavy cracking (> 2.0 mm) of the mortar or loss of mortar between blocks. Blocks may have started slipping. Mortar has become powdery.</p>	<p>General: Components are showing signs of distress or have already failed. Defects affect the structural integrity or ability to withstand water flows. Water flow is likely to result in loss of pavement and/or culvert. The road surface is uneven.</p>

Severity Level Ratings

Component	1	2	3	4	5
<p>Culvert Units</p> <p><i>Applicable to:</i></p> <ul style="list-style-type: none"> • Boxes • Pipes • Culvert bases • Joints • Link slabs • Timber decking • Abutment walls • Pier walls <p><i>Materials:</i></p> <ul style="list-style-type: none"> • Cast in situ concrete • Precast concrete • Steel • Timber 	<p>General: In good condition with little or no deterioration. The line and invert of the culvert is straight with no water being retained.</p> <p>And: Concrete: Hairline cracking (≤ 0.1 mm), cracks widely spaced and very infrequent. No spalling. Minor efflorescence on the underside or near joints.</p> <p>Steel: No evidence of corrosion.</p>	<p>General: Defects are more surface in nature and do not affect the structural integrity. The line and invert of the culvert is straight but there is minor differential settlement (≤ 5 mm) with some ponding.</p> <p>And: Concrete: Fine cracking (> 0.1 & ≤ 0.3 mm), cracks widely spaced and very infrequent. Minor localised spalling and rust staining may be present. No reinforcement is exposed. Damp patches may be visible.</p> <p>Steel: Localised superficial surface corrosion and no pitting.</p>	<p>General: Defects are still not affecting structural integrity but are more than cosmetic. There may be some deviation of the line of the culvert due to local buckling, separation or differential settlement (> 5 & ≤ 30 mm) with ponding.</p> <p>And: Concrete: Medium cracking (> 0.3 & ≤ 0.7 mm) infrequent. Fretting and/or spalling may be present. Extensive rust staining. Patches of dampness and efflorescence of 0.25 m^2 to 1 m^2 may be visible in any one unit.</p> <p>Steel: Steel corrosion can be widespread but no flaking is evident. Surface pitting may be evident at normal water level.</p>	<p>General: Significant deterioration or damage affecting structural integrity. There may be a large deviation of the line of the culvert (> 30 mm) which may result in excessive water being retained in the culvert.</p> <p>And: Concrete: Heavy cracking (> 0.7 mm) with fretting and/or spalling along large delaminated areas. Any exposed reinforcement exhibits signs of severe corrosion over large areas resulting in substantial loss of section. Patches of dampness and efflorescence may be $> 1 \text{ m}^2$ in any one unit.</p> <p>Steel: Extensive steel corrosion, surface pitting and extensive flaking with loss of section. Noticeable loss of section $\geq 10\%$ of circumference.</p>	<p>General: Components are showing signs of distress or have already failed. Defects affect the structural integrity or ability to withstand water flows. Water flow is likely to result in loss of pavement and/or culvert. The road surface is uneven.</p>
	<p><i>Coating defects are a serious concern for culverts. Loss of a protective coating for components that are often submerged can result in accelerated deterioration. However, coating defects are not necessarily serious or structural in their own right but are indicative of potential weaknesses and need to be inspected and reported accordingly.</i></p>				
	<p>Timber: May have very minor splits only.</p>	<p>Timber: Minor rot zones. May have splitting or weathering.</p>	<p>Timber: Rot is more advanced. Splits are evident.</p>	<p>Timber: Little solid timber remaining or timber has become fully friable. Splits may be severe.</p>	