



mainroads
WESTERN AUSTRALIA

*We're working for
Western Australia.*

Guidelines for Transporting Multiple Items on an Oversize or Over-mass Vehicle

Printed copies are uncontrolled unless marked otherwise.
Refer to Main Roads website for current version.

D17#306203
August 2024

Contents

REFERENCES AND RELATED DOCUMENTS.....	4
DEFINITIONS	5
1 PURPOSE	6
2 EXCEEDING DIMENSION LIMITS	6
2.1 Carrying Multiple Items and Exceeding Width Limits.....	6
2.2 Carrying Multiple Items and Exceeding Length Limits	7
2.3 Carrying Multiple Items and Exceeding Height Limits	10
2.4 Carrying Multiple Items and Exceeding Width and Height Limits	10
3 EXCEEDING MASS LIMITS	11
3.1 Carry Items Removed from a Large Indivisible Item.....	11
3.2 Carrying Other Items with an Over-mass Large Indivisible Item	11

Document Control

Owner	Director Heavy Vehicle Services
Custodian	Manager Heavy Vehicle Road Network Access
Document Number	D17#306203
Issue Date	6 November 2020
Review Frequency	As Required

Amendments

Revision Number	Revision Date	Description of Key Changes	Section
1	6/02/2018	Additional item permitted to exceed statutory height limits.	cl. 2.4
2	6/11/2020	Included definition for statutory dimension limits and formatted document.	All
3	26/09/2023	Updated document and images for clarity.	All
4	08/08/2024	Amended provisions to allow a low loader or platform trailer to carry items removed from the mining machine being carried.	cl. 2.2.3 and 3.1.1

REFERENCES AND RELATED DOCUMENTS

The following documents relate to these Guidelines and are available on the Main Roads website:

Document Name	Location
Class 1 RAV 8 Tyre Per Axle Low Loader Overmass Period Permit Operating Conditions	Available on the Oversize Overmass (OSOM) page on the Main Roads website: https://www.mainroads.wa.gov.au/globalassets/heavy-vehicles/getting-a-permit/osom/class-1-rav-8-tyre-per-axle-low-loader-overmass-period-permit-operating-conditions.pdf?v=4aa9a8
Class 1 RAV - Low Loader Overmass Period Permit Operating Conditions	Available on the Oversize Overmass (OSOM) page on the Main Roads website: https://www.mainroads.wa.gov.au/globalassets/heavy-vehicles/getting-a-permit/osom/class-1-rav-low-loader-overmass-period-permit-operating-conditions.pdf?v=4a2aa2
Class 1 RAV Oversize Period Permit Operating Conditions	Available on the Oversize Overmass (OSOM) page on the Main Roads website: https://www.mainroads.wa.gov.au/globalassets/heavy-vehicles/getting-a-permit/osom/class-1-rav-oversize-period-permit-operating-conditions.pdf?v=4a0df7
Class 1 RAV Restricted Area Low Loader Overmass Period Permit Operating Conditions	Available on the Oversize Overmass (OSOM) page on the Main Roads website: https://www.mainroads.wa.gov.au/globalassets/heavy-vehicles/getting-a-permit/osom/class-1-rav-restricted-area-low-loader-overmass-period-permit-operating-conditions.pdf?v=49b8c5
Oversize Road Train & B-double Operating Conditions	Available on the Oversize Road Trains & B Doubles page on the Main Roads website: https://www.mainroads.wa.gov.au/globalassets/heavy-vehicles/getting-a-permit/oversize-road-train-b-double/oversize-road-train-and-b-double-period-permit-operating-conditions.pdf?v=49b911
Platform Trailer Relocation Period Permit Operating Conditions	Available on the Oversize Overmass (OSOM) page on the Main Roads website: https://www.mainroads.wa.gov.au/globalassets/heavy-vehicles/getting-a-permit/osom/platform-trailer-relocation-period-permit-operating-conditions-18-july-2023.pdf?v=4a1646
Road Train with Long Trailers Period Permit Operating Conditions	Available on the Road Train with Long Trailers page on the Main Roads website: https://www.mainroads.wa.gov.au/heavy-vehicles/permit-order-scheme/road-trains-with-long-trailers/
Single Trip Oversize Vehicle Standard Operating Conditions	Available on the Oversize Overmass (OSOM) page on the Main Roads website: https://www.mainroads.wa.gov.au/globalassets/heavy-vehicles/getting-a-permit/osom/single-trip-osom-vehicle-standard-operating-conditions-hvs.pdf?v=4a0d98

DEFINITIONS

The following are definitions for terms used in these Guidelines. Refer to the definitions in the *Road Traffic (Administration) Act 2008* and the *Road Traffic (Vehicles) Act 2012* and any subsidiary legislation to these Acts for the meanings of any terms not defined in this section. If a definition in the relevant Acts or the subsidiary legislation conflicts with a definition in this section, the definition in this section prevails for the purpose of these Guidelines.

Term	Definition
Conventional Vehicle	A vehicle that is readily available on the market and meets all statutory dimension requirements, i.e. licensed as an 'A' class vehicle.
Large Indivisible Item	<p>An item that cannot be divided without extreme effort, expense or risk of damage to it; and cannot be carried on any vehicle without exceeding a mass or dimension limit.</p> <p>For the purpose of this guideline, this includes equipment that is essential for transporting the large indivisible load, such as customised framing necessary to support the large indivisible load.</p>
Main Roads Website	www.mainroads.wa.gov.au
Overmass	Resulting in the vehicle exceeding the statutory mass limits.
Oversize	Resulting in the vehicle exceeding the statutory dimension limits.
S-dimension	The distance measured from the semi-trailer's kingpin to the centre of its rear axle group.
Statutory Dimension Limits	The dimension limits prescribed in Part 8 of the <i>Road Traffic (Vehicles) Regulations 2014</i> .
Statutory Mass Limits	The mass limits prescribed in Part 8 of the <i>Road Traffic (Vehicles) Regulations 2014</i> .

1 PURPOSE

The purpose of this document is to provide a clear understanding of the requirements associated with transporting multiple items on an oversize and/or overmass vehicle.

An oversize and overmass vehicle must comply with these guidelines, unless the contrary intention appears in the permit operating conditions.

2 EXCEEDING DIMENSION LIMITS

Exemptions for exceeding dimension limits are only given when the large indivisible item cannot be carried on a conventional vehicle without exceeding statutory dimension limits. Allowing dimension limits to be exceeded unnecessarily due to an operator using an inappropriate vehicle, or as a result of carrying multiple items, will have an adverse effect on road safety and commercial equity.

However, under certain circumstances, Main Roads will allow multiple items to be carried when a dimension limit is being exceeded. The circumstances are as follows.

2.1 Carrying Multiple Items and Exceeding Width Limits

2.1.1 A vehicle carrying an oversize large indivisible item may carry other items, provided they do not result in the vehicle exceeding the width of the large indivisible item.

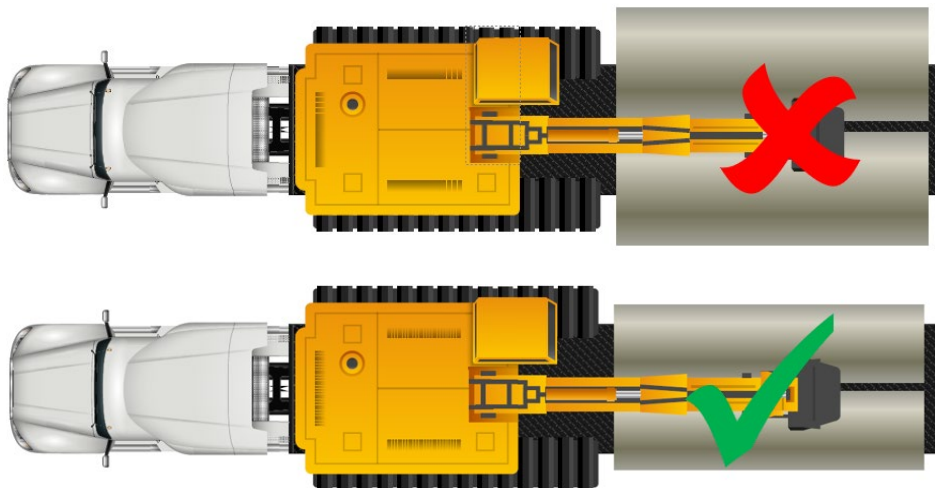

2.1.2 Multiple items must not be loaded side by side if it results in the overall width exceeding 2.5 metres, regardless of the trailer width.

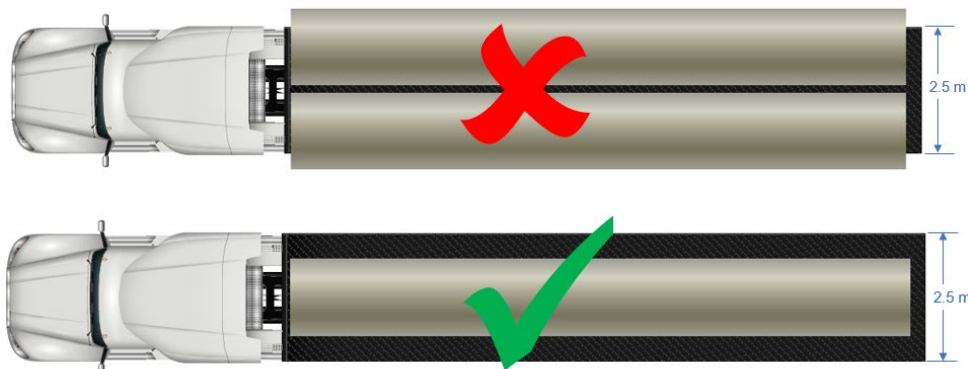

2.2 Carrying Multiple Items and Exceeding Length Limits

2.2.1 Unless otherwise specified under this clause, multiple items must not be loaded front to back on a prime mover and semi-trailer combination if it results in the length, measured from the front of the vehicle combination to the rear of the load, exceeding 19 metres, regardless of the semi-trailer length, i.e. an overlength trailer must not be used to gain a commercial advantage to carry multiple items.

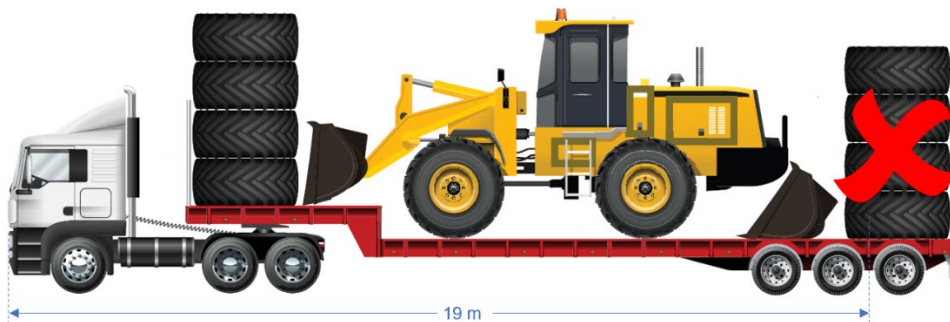
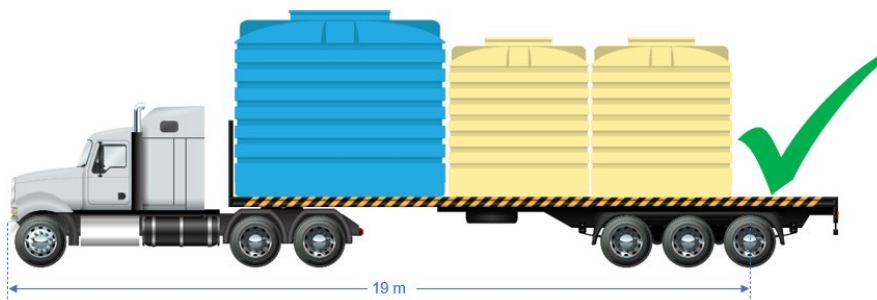
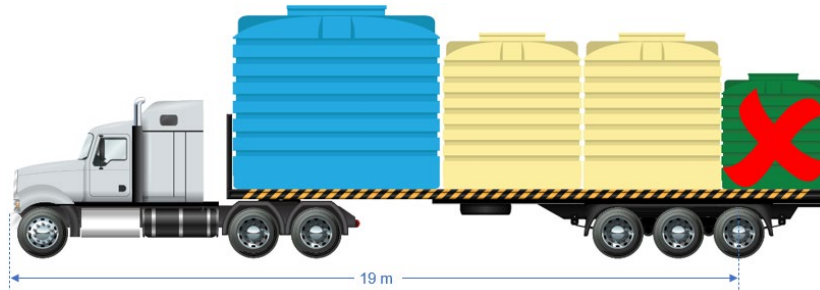

2.2.2 A low loader or platform trailer may carry the following multiple items:

- (a) a dolly, provided there is no dolly in the vehicle combination; and/or
- (b) a pilot vehicle; and/or
- (c) loading equipment.



2.2.3 A low loader or platform trailer, with at least 8 tyres per axle and loaded with a mining machine, such as a dump truck, may carry additional items, provided:

- (a) The additional items have been removed from the mining machine, such as the tray or wheels from the dump truck chassis; and
- (b) The overall vehicle combination length does not exceed 50 metres, or
- (c) The additional items are necessary for the loading / unloading of the mining machine.



2.2.4 If an over-length trailer is loaded with an oversize special purpose vehicle, such as a front-end loader, or an oversize agricultural vehicle, the vehicle may also carry additional items provided:

- (a) The additional items are an integral part of the oversize special purpose vehicle or oversize agricultural vehicle and are necessary for its operation; or
- (b) The additional items are necessary for the loading/unloading of the oversize special purpose vehicle or oversize agricultural vehicle.



2.2.5 Multiple items must not be loaded front to back on a rigid truck and pig trailer (or tag trailer) combination if it results in the length, measured from the front of the vehicle combination to the rear of the load, exceeding 20 metres in overall length or an allowable vehicle dimension limit, such 12.5 metres for the rigid vehicle, or 3.7 metres rear overhang.

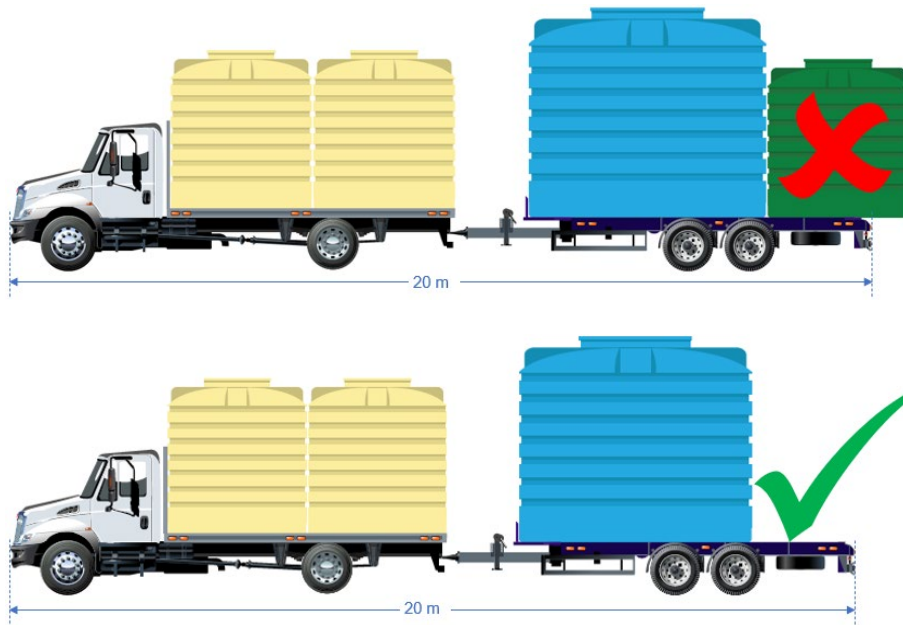

2.2.6 Multiple items must not be loaded front to back on a rigid truck and dog trailer combination, if it results in the length exceeding 25 metres in overall length or an allowable vehicle dimension limit, such 12.5 metres for the rigid vehicle, or 3.7 metres rear overhang.



2.2.7 Multiple items must not be loaded front to back on a road train or B-double, if it results in the length exceeding the allowable road train or B-double overall length or an allowable trailer dimension, such as 3.7 metres rear overhang.





2.3 Carrying Multiple Items and Exceeding Height Limits

2.3.1 Multiple items must not be stacked if it results in the overall height exceeding 4.3 metres;

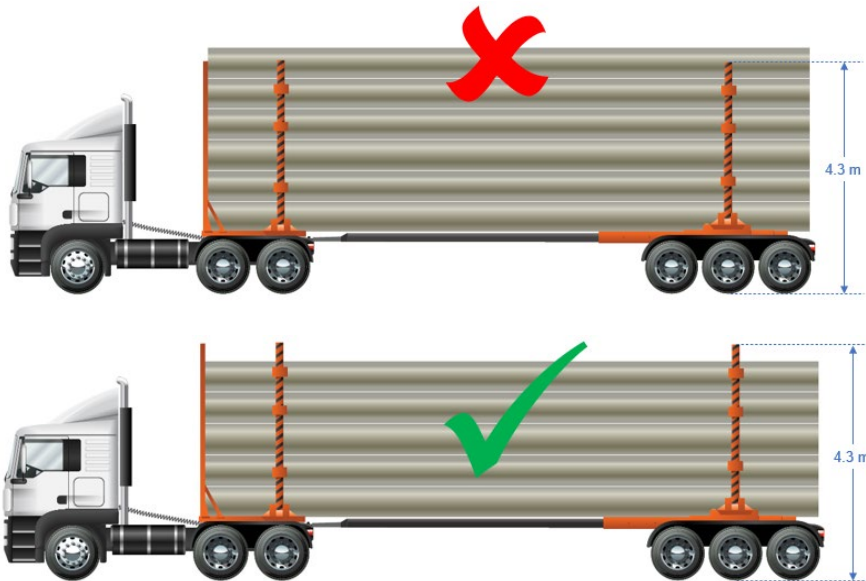

2.3.2 Despite sub-clause 2.3.1, swimming pools packaged and consigned for export may be stacked to a maximum loaded height not exceeding 5.3 metres.

2.4 Carrying Multiple Items and Exceeding Width and Height Limits

2.4.1 Multiple items may be loaded together, each exceeding a different height and width limit, provided the allowable height and width limits under the relevant permit are not exceeded.

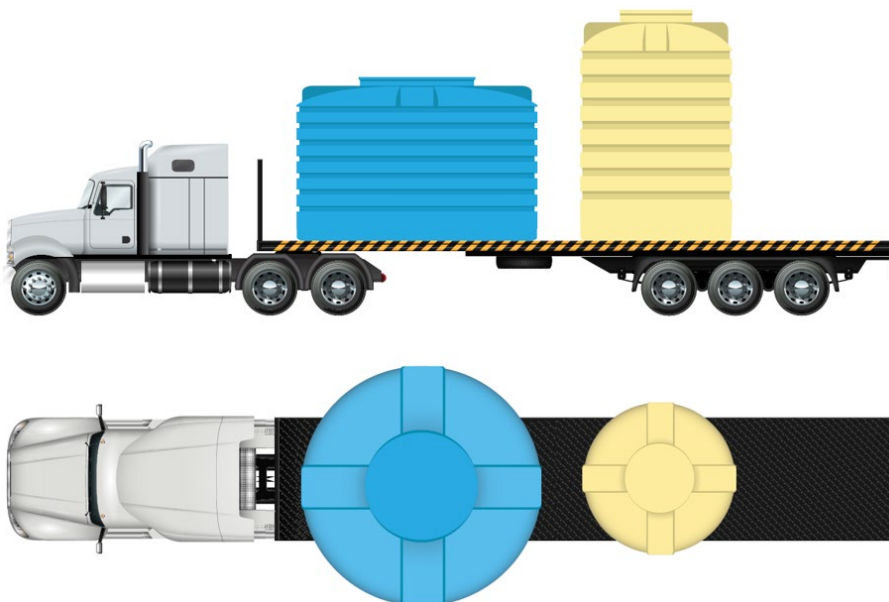

3 EXCEEDING MASS LIMITS

Similar to dimension limit exemptions, exemptions for exceeding mass limits are only given when the load cannot be carried on a conventional vehicle without exceeding statutory mass limits, or cannot be dismantled to reduce the mass of the load. Allowing mass limits to be exceeded unnecessarily due to an operator using an inappropriate vehicle, or as a result of carrying multiple items or a divisible item, will have an adverse effect on road infrastructure sustainability, road safety and commercial equity.

However, under certain circumstances, Main Roads will allow multiple items or divisible items to be carried when mass limits are being exceeded. The circumstances are as follows.

3.1 Carry Items Removed from a Large Indivisible Item

3.1.1 A low loader or platform trailer, with at least 8 tyres per axle and loaded with a mining machine, such as a dump truck, may carry additional items, provided the additional items have been removed from the mining machine to reduce the dimensions, such as the tray or wheels from the dump truck chassis.



3.1.2 A vehicle may carry multiple items removed from a large indivisible item that is being transported on a separate vehicle, provided:

- (a) The items have been removed from the large indivisible item for the purpose of reducing its mass or dimensions; and
- (b) The items have the same journey start and end points; and
- (c) The permit applications for the vehicle carrying the main larger indivisible item and the vehicle carrying the removed items have been lodged together and the permits reference each other; and
- (d) The vehicle used to transport the removed items is not a platform trailer; and
- (e) The total mass of the vehicle combination does not require Bridge Supervision.

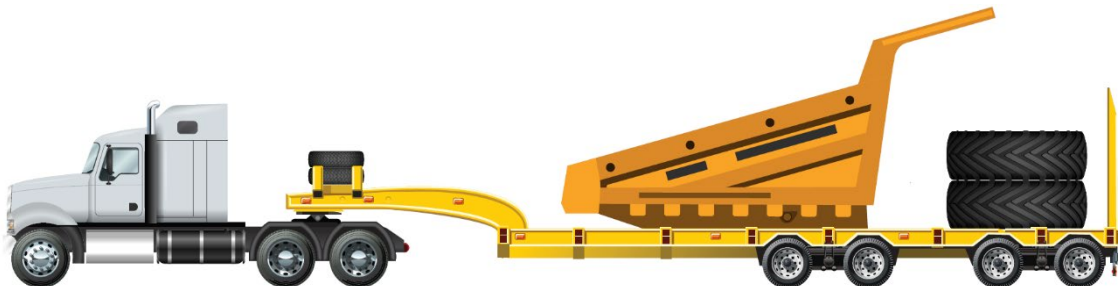

3.2 Carrying Other Items with an Over-mass Large Indivisible Item

A vehicle carrying an over-mass large indivisible item may carry other items, provided:

(a) The over-mass large indivisible item is an agricultural implement or road construction implement and the additional item is a tractor needed to provide motive power to the implement; or

- (b) The additional items are an integral part of the over-mass large indivisible item, such as equipment, tools, substances or detached parts necessary for the operation of the indivisible item; or
- (c) The items are necessary for the loading/unloading of the over-mass large indivisible item; or
- (d) The item is a low loader dolly and there is no low loader dolly forming part of the vehicle combination.

